



OUR GLOBAL
COMPETENCE
CENTRES

 APOLLO DISPLAY
TECHNOLOGIES



 DISTEC



 DISPLAY
TECHNOLOGY



Datasheet

Tianma

TM046JDHP01-30

TI-60-009

MODEL NO : TM046JDHP01**MODEL VERSION: 30****SPEC VERSION : 1.1****ISSUED DATE: 2016-07-11**

- Preliminary Specification
- Final Product Specification

Customer : _____

Approved by	Notes

TIANMA Confirmed :

Prepared by	Checked by	Approved by
Xianchen.Fu	Fan.Jiang	Feng.Qin

This technical specification is subjected to change without notice

Table of Contents

Table of Contents	2
Record of Revision	3
1. General Specifications	4
2. Input/Output Terminals	5
3. Absolute Maximum Ratings	6
4. Electrical Characteristics	7
5. INTERFACE TIMING	9
6. POWER ON/OFF SEQUENCE	11
7. Optical Characteristics	12
8. Environmental / Reliability Test	15
9. Mechanical Drawing	16
10. Packing Drawing	17
11. Precautions for Use of LCD Modules	18

Record of Revision

Rev	Issued Date	Description	Editor
1.0	2015-12-22	Preliminary Specification Release	Xianchen.Fu
1.1	2016-07-11	Modified format	Chen lifeng

1. General Specifications

Feature		Spec
Display Spec.	Size	4.66 inch
	Resolution	720(RGB) x1280
	Pixel Configuration	R.G.B. Vertical Stripe
	Pixel pitch(mm)	0.0807*0.0807
	Technology Type	a-Si
	Surface Treatment	HC
	Display Mode	Normally Black
	Viewing Direction	ALL
Mechanical Characteristics	LCM (W x H x D) (mm)	61.60*113.18*1.43
	Active Area(mm)	58.104 * 103.296
	With/Without TSP	Without TSP
	Matching Connection Type	Kyocera 24-5804-024-000-829+
	Weight (g)	15.6
	LED Numbers	10 LEDs
Electronic	Interface	MIPI
	Color Depth	16.7M
	Driver IC	ILI9881C

Note 1: Viewing direction for best image quality is different from TFT definition; there is a 180 degree shift.

Note 2 : Requirements on Environmental Protection: Q/S0002

Note 3 : LCM weight tolerance : +/- 5%

2. Input/Output Terminals

No	Symbol	I/O	Description	Comment
1	GND	P	Power Ground	
2	DATA0N	I/O	MIPI DSI 0 lane(0-)	
3	DATA0P	I/O	MIPI DSI 0 lane(0+)	
4	GND	P	Power Ground	
5	CLKN	I/O	MIPI DSI CLK(-)	
6	CLKP	I/O	MIPI DSI CLK(+)	
7	GND	P	Power Ground	
8	DATA1N	I/O	MIPI DSI 1 lane(0-)	
9	DATA1P	I/O	MIPI DSI 1 lane(0+)	
10	GND	P	Power Ground	
11	DATA2N	I/O	MIPI DSI 2 lane(0-)	
12	DATA2P	I/O	MIPI DSI 2 lane(0+)	
13	GND	P	Power Ground	
14	LED+	P	Anode for back-light LED lightbar	
15	LED-	P	cathode for back-light LED lightbar	
16	ID	O	LCM ID Pin for customer identify (ID=1.8V)	
17	VCI	P	Analog power supply	
18	IOVCC	P	Interface and Logic power supply	
19	TE	O	Tearing effect output signal, Leave it open if not used.	
20	CABC	O	PWM signal output control brightness of LED back-light.	
21	RESET	I	Reset pin, IC is initialized when Reset is low.	
22	GND	P	Power Ground	
23	DATA3P	I/O	MIPI DSI 3 lane(0+)	
24	DATA3N	I/O	MIPI DSI 3 lane(0-)	

Table 2.1 Input terminal pin assignment

Note 1: I/O-----Input/Output
 I-----Input
 O-----Output
 P-----Power/Ground

3. Absolute Maximum Ratings

GND=0V

Item	Symbol	MIN	MAX	Unit	Remark
Logic Supply Voltage	IOVCC	-0.3	4.5	V	
Analog Supply Voltage	VCI	-0.3	4.8	V	
Logic Input voltage	I/O PINS	-0.3	IOVCC+0.3	V	
Back Light Forward Current	I _{LED}	-	25	mA	For each LED
Operating Temperature	TOPR	-20	70	°C	
Storage Temperature	TSTG	-30	80	°C	
Relative Humidity Note1	RH	--	≤95	%	Ta≤40°C
		--	≤85	%	40°C < Ta ≤ 50°C
		--	≤55	%	50°C < Ta ≤ 60°C
		--	≤36	%	60°C < Ta ≤ 70°C
		--	≤24	%	70°C < Ta ≤ 80°C
Absolute Humidity	AH	--	≤70	g/m ³	Ta>70°C

Table 3.1 Absolute maximum ratings

Note1: Ta means the ambient temperature.

It is necessary to limit the relative humidity to the specified temperature range.

Condensation on the module is not allowed.

4. Electrical Characteristics

4.1 Driving TFT LCD Panel

GND=0V, Ta=25°C

Item	Symbol	MIN	TYP	MAX	Unit	Remark
Logic Supply Voltage	IOVCC	1.65	1.8	3.3	V	
Analog Supply Voltage	VCI	2.3	2.8	4.8	V	
Input Signal Voltage	Low Level	V_{IL}	0	-	$0.3^* IOVCC$	V
	High Level	V_{IH}	$0.7^* IOVCC$	-	IOVCC	V
Output Signal Voltage	Low Level	V_{OL}	0	-	$0.2^* IOVCC$	V
	High Level	V_{OH}	$0.8^* IOVCC$	-	IOVCC	V
(Panel+LSI) Power Consumption	Black Mode (60Hz)	-	--	-	mW	
	Sleeping Mode	-	TBD	-	mW	

Table 4.1.1 LCD module electrical characteristics

4.2 Driving Backlight

Ta=25°C

Item	Symbol	MIN	TYP	MAX	Unit	Remark
Forward Current	I_F	--	20	--	mA	For each LED
Forward Current Voltage	V_F	--	3.2	--	V	For each LED
Backlight Power Consumption	W_{BL}	--	64	--	mW	For each LED
LED Lifetime	--	--	20000	--	Hrs	

Table 4.2.1 Backlight unit electrical characteristics

Note 1: The figure below shows the connection of backlight LED.



Figure 4.2.1 LED backlight circuit

 Note 2: One LED : $I_F = 20 \text{ mA}$, $V_F = 3.2 \text{ V}$

 Note 3: I_F is defined for one channel LED.

Optical performance should be evaluated at Ta=25°C only.

If LED is driven by high current, high ambient temperature & humidity condition. The life time of LED will be reduced. Operating life means brightness goes down to 50% initial brightness. Typical operating life time is estimated data.

4.3 Block Diagram

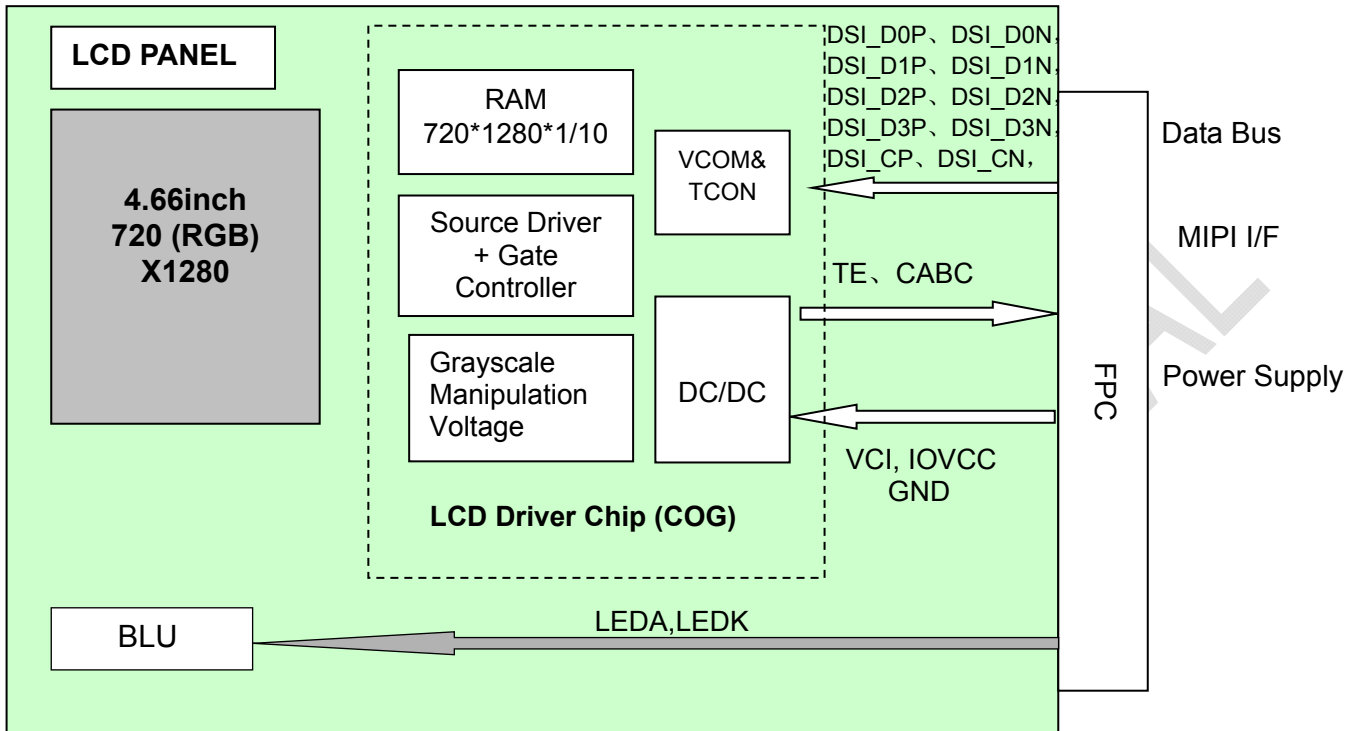

Figure 4.3.1 LCD module diagram

5. INTERFACE TIMING

5.1 DC Characteristics for Panel Driving

Item	Symbol	Condition	Min.	Typ.	Max.	Unit	Note
Power & Operation Voltage							
Analog operating voltage	VCI	-	2.5	2.8	6.0	V	
Analog operating voltage	VCIREF	-	2.5	2.8	6.0		
Digital operating voltage	VDDI	-	1.65	2.8	3.3	V	
Digital operating voltage	VCC1	-	1.65	2.8	6.0	V	
Digital operating voltage	VCC2	-	1.65	2.8	6.0	V	
DSI operating voltage	VDDAM	-	1.65	1.8	3.3	V	
OTP Supply voltage	MTP_PWR	-	8.4	8.5	8.6	V	
Analog operating voltage	VSP	-	4.5		6	V	
Analog operating voltage	VSN	-	-6		-4.5	V	
Logic High level input voltage	VIH	-	0.7*VDDI		VDDI	V	Note1
Logic Low level input voltage	VIL	-	-0.3		0.3*VDDI	V	Note1
Logic High level output voltage TE , LEDPWM	VOH	IOH = -1.0mA	0.8*VDDI		VDDI	V	Note1
Logic Low level output voltage TE , LEDPWM	VOL	IOL = +1.0mA	0		0.2*VDDI	V	Note1
Gate Driver High Voltage	VGH	-	8.0	-	18	V	
Gate Driver Low Voltage	VGL	-	-18.0	-	-7.0	V	
Driver Supply Voltage	-	[VGH-VGL]	15	-	32	V	
VCOM Operation							
DC VCOM Amplitude Voltage	VCOM	-	-4.0	-	0	V	Note3
Source Driver							
Source Output Range	VSOUT(+)	-	0.3	-	VREG1OUT-0.1	V	Note4
	VSOUT(-)	-	VREG2OUT +0.1	-	-0.3	V	Note4
Positive Gamma Reference Voltage	VREG1OUT	-	2.9	-	VSP-0.5	V	
Negative Gamma Reference Voltage	VREG2OUT	-	VSN+0.5	-	-2.9	V	
Source Output Setting Time	Tr	Below with 99% precision	-	10	-	uS	Note3.4
Output Deviation Voltage (Source Output channel)	Vdev	Sout>=4.2V	-	-	20	mV	Note3
		Sout<=0.8V	-	-	15	mV	
Output Offset Voltage	VOFFSET	-	-	-	35	mV	Note3
Standby mode current consumption							
Sleep In mode	I(VDDI SLP IN)	Ta = 25 °C VCI=2.8V	-	35	-	uA	
	I(VCI SLP IN)	VDDI=1.8V	-	25	-	uA	

Table 5.1.1 Data to Clock Timing Specifications

Note 1: VCI = 2.5V to 6.0V, VDDI = 1.65V to 3.3V.

Note 2: Supply digital VDDI voltage equal or less than analog VCI voltage.

Note 3: Source channel loading = 9K Ω , 70pF/channel.

Note 4: The maximum value is between with Note3 and Gamma setting value.

5.2 Reset Timing Characteristics(Ta=25°C)

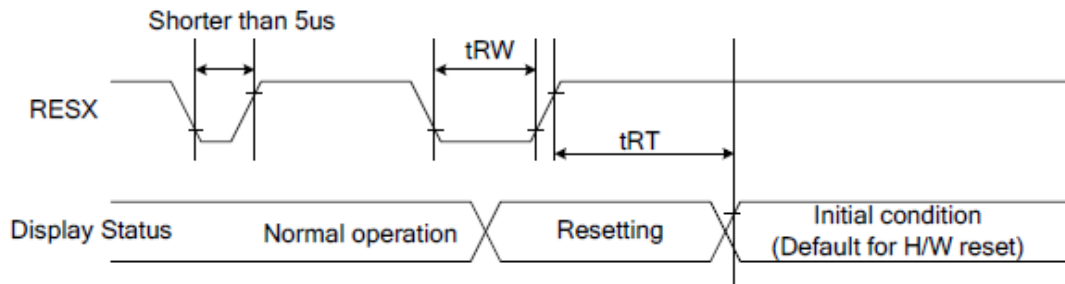

Figure5.2.1 Reset input timing

Signal	Symbol	Parameter	Min	Max	Unit
RESX	tRW	Reset pulse duration	10	-	mA
	tRT	Reset cancel	-	5(note 1)	V
			-	120(note 2,3)	

Table 5.2.1 Reset input timing Spec

Note 1: When Reset applied during Sleep In Mode.

Note 2: When Reset applied during Sleep Out Mode.

Note 3: It is necessary to wait 5msec after releasing RESX before sending commands. Also Sleep Out command cannot be sent for 120msec.

6. POWER ON/OFF SEQUENCE

Case A:

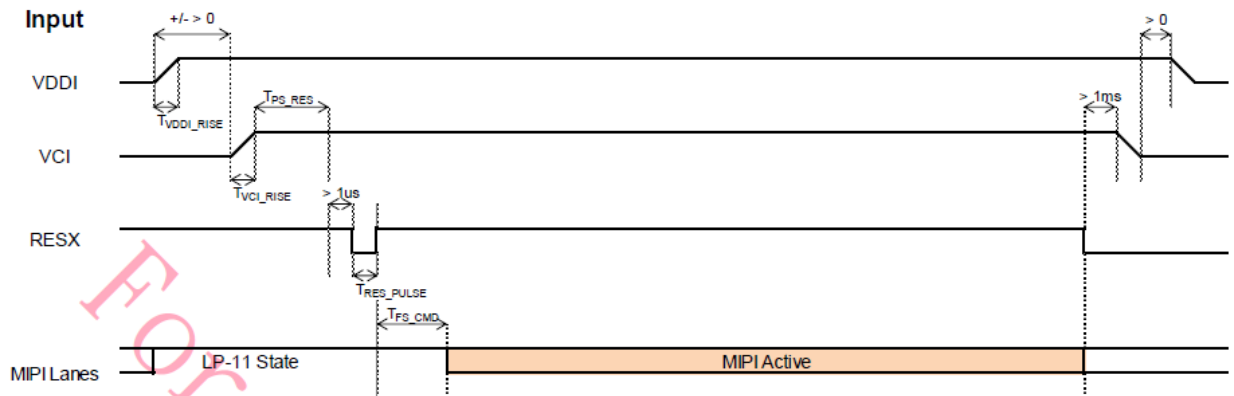

Case B:

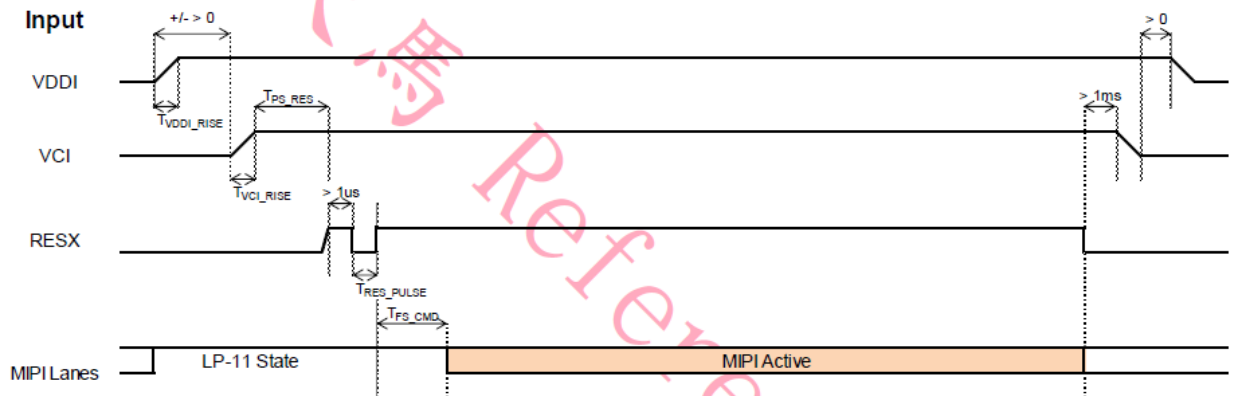

Figure6.1.1 Power on/off Sequence

Symbol	Characteristics	Min.	Typ.	Max.	Units
T_{VDDI_RISE}	VDDI Rise time	20	-	-	us
T_{VCI_RISE}	Case A: VCI Rise time	200	-	-	us
	Case B: VCI Rise time	40	-	-	us
T_{PS_RES}	VDDI/VCI on to Reset high	5	-	-	ms
T_{RES_PULSE}	Reset low pulse time	10	-	-	us
T_{FS_CMD}	Reset to first command	10	-	-	ms

Table 6.1.1 Power on/off timing Spec

7. Optical Characteristics

Ta=25°C

Item	Symbol	Condition	Min	Typ	Max	Unit	Remark	
View Angles	θT	$CR \geq 10$	75	85	-	Degree	Note 2	
	θB		75	85	-			
	θL		75	85	-			
	θR		75	85	-			
Contrast Ratio	CR	$\theta=0^\circ$	600	800	-	-	Note1 Note3	
Response Time	T_{ON}	25°C	-	25	35	ms	Note1 Note4	
	T_{OFF}							
Chromaticity	White	Backlight is on	x	0.257	0.307	0.357	-	Note5 Note1
			y	0.270	0.320	0.370		
	Red		x	0.591	0.641	0.691		
			y	0.303	0.353	0.403		
	Green		x	0.275	0.325	0.375		
			y	0.568	0.618	0.668		
	Blue		x	0.104	0.154	0.204		
			y	0.004	0.054	0.104		
Uniformity	U	-	80	85	-	%	Note1 Note6	
NTSC	-	-	65	70	-	%	Note 5	
Luminance	L		350	400	-	cd/m ²	Note1 Note7	

Test Conditions:

1. $V_F=3.2V$, $I_F=20mA$ (One LED current), the ambient temperature is 25°C.
2. The test systems refer to Note 1 and Note 2.

Note 1: Definition of optical measurement system.

The optical characteristics should be measured in dark room. After 5 Minutes operation, the optical properties are measured at the center point of the LCD screen. All input terminals LCD panel must be ground when measuring the center area of the panel.

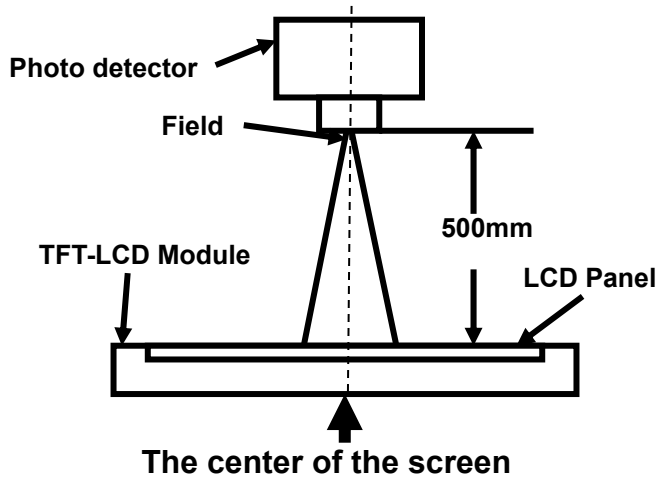

Note 2: Definition of viewing angle range and measurement system.

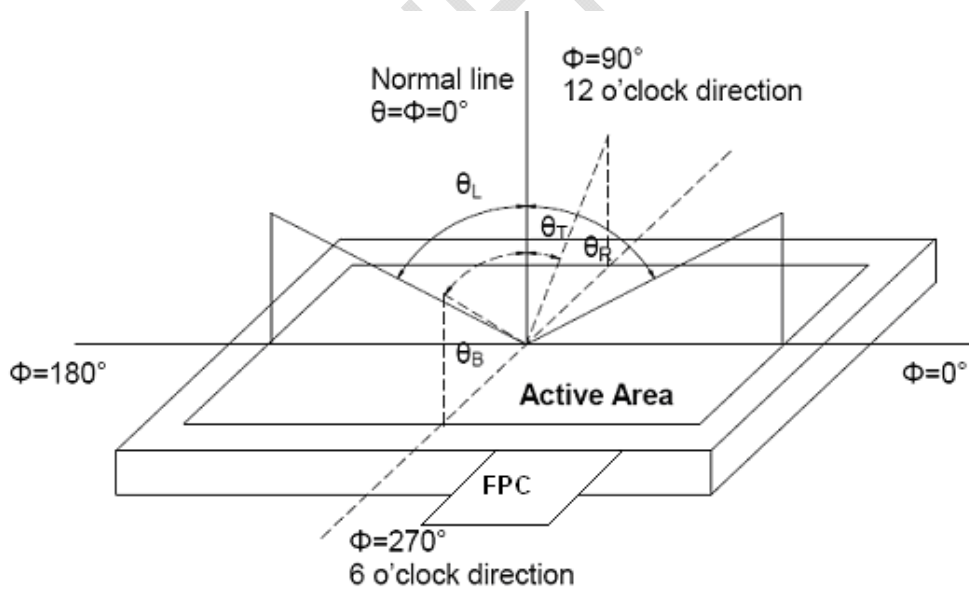

Note 3: Definition of contrast ratio

$$\text{Contrast ratio (CR)} = \frac{\text{Luminance measured when LCD is on the "White" state}}{\text{Luminance measured when LCD is on the "Black" state}}$$

“White state “: The state is that the LCD should drive by V_{white} .

“Black state”: The state is that the LCD should drive by V_{black} .

V_{white} : To be determined V_{black} : To be determined.

Note 4: Definition of Response time

The response time is defined as the LCD optical switching time interval between “White” state and “Black” state. Rise time (T_{ON}) is the time between photo detector output intensity changed from 90% to 10%. And fall time (T_{OFF}) is the time between photo detector output intensity changed from 10% to 90%.

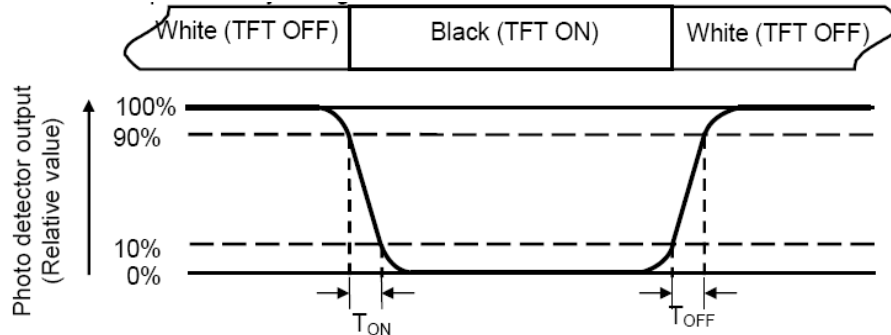

Note 5: Definition of color chromaticity (CIE1931)

Color coordinates measured at center point of LCD.

Note 6: Definition of Luminance Uniformity

Active area is divided into 9 measuring areas (Refer Fig. 2). Every measuring point is placed at the center of each measuring area.

$$\text{Luminance Uniformity (U)} = L_{\min} / L_{\max}$$

L-----Active area length W----- Active area width

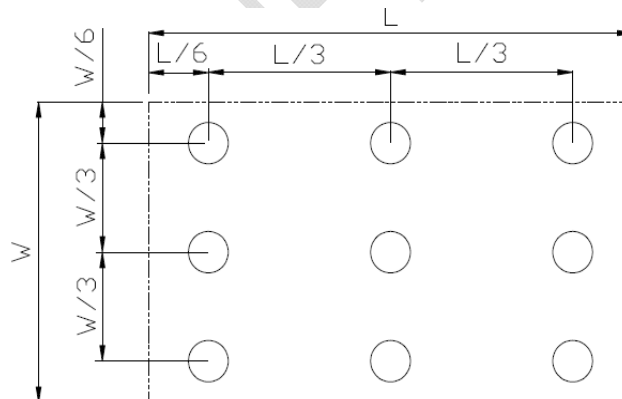

L_{\max} : The measured Maximum luminance of all measurement position.

L_{\min} : The measured Minimum luminance of all measurement position.

Note 7: Definition of Luminance:

Measure the luminance of white state at center point.

8. Environmental / Reliability Test

No	Test Item	Condition	Remark
1	High Temperature Operation	Ts=+70°C, 240hrs	Note1 IEC60068-2-1:2007,GB2423.2-2008
2	Low Temperature Operation	Ta=-20°C,240hrs	IEC60068-2-1:2007 GB2423.1-2008
3	High Temperature Storage	Ta=+80°C, 240hrs	IEC60068-2-1:2007 GB2423.2-2008
4	Low Temperature Storage	Ta=-30°C, 240hrs	IEC60068-2-1:2007 GB2423.1-2008
5	High Temperature & High Humidity Storage	Ta=+60°C, 90% RH 240 hours	Note2 IEC60068-2-78 :2001 GB/T2423.3—2006
6	Thermal Shock (Non-operation)	-30°C 30 min~+80°C 30 min, Change time:5min, 100 Cycles	Start with cold temperature, End with high temperature, IEC60068-2-14:1984,GB2423.22-2002
7	Electro Static Discharge (Operation)	C=150pF, R=330Ω,5points/panel Air:± 8KV, 5times, Contact:± 4KV, 5 times, (Environment: 15°C~35°C, 30%~60%, 86Kpa~106Kpa)	IEC61000-4-2:2001 GB/T17626.2-2006
8	Vibration (Non-operation)	Frequency range:10~55Hz, Stroke:1.5mm Sweep:10Hz~55Hz~10Hz 2 hours for each direction of X.Y.Z. (6 hours for total)	IEC60068-2-6:1982 GB/T2423.10—1995
9	Shock (Non-operation)	Half Sine Wave, 100G 6ms, ± X,± Y,± Z 3times, for each direction	IEC60068-2-27:1987 GB/T2423.5—1995

Note1: Ts is the temperature of panel's surface.

Note2: Ta is the ambient temperature of sample.

9. Mechanical Drawing

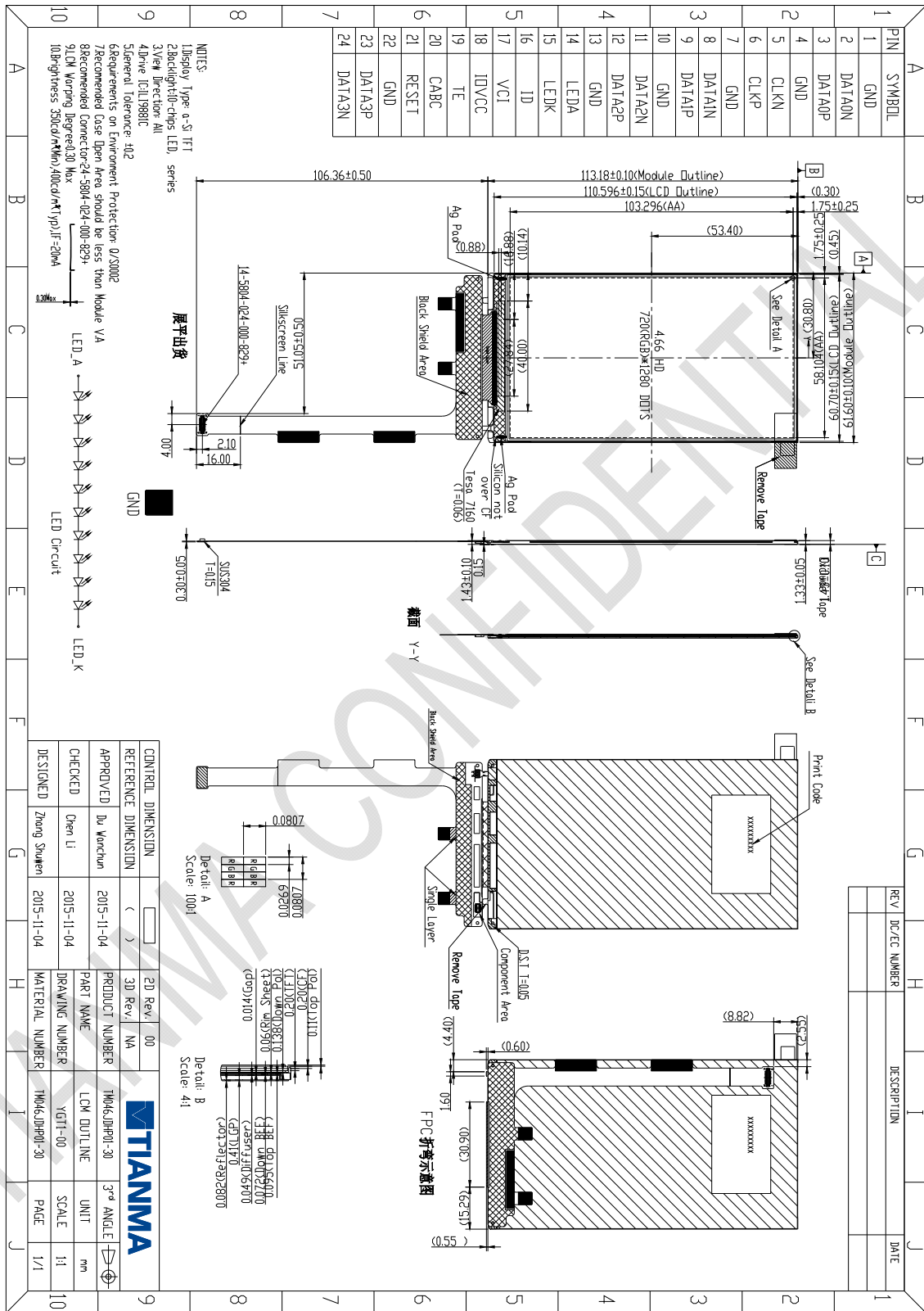

10. Packing Drawing

10.1 Packing Material

No	Item	Model (Materiel)	Dimensions(mm)	Unit Weight(Kg)	Quantity	Remark
1	LCM module	TM046JDHP01-30	61.60×113.18×1.43	0.0156	144	
2	Tray	PET (Transmit)	485×330×13.8	0.161	27	Anti-static
3	Vacuum Bag	PE	600×500	0.047	3	
4	BOX	CORRUGATED PAPER	520×345×74	0.369	3	
5	Label	Paper	100×52	TBD	1	
6	Desiccant	Desiccant	45×35	0.002	6	
7	Carton	CORRUGATED PAPER	544×365×250	0.76	1	
8	Total weight	TBD				

10.2 Packing Specification and Quantity

(1) LCM quantity per tray: 6 PCS
(2) Total LCM quantity in Carton: No. of PET trays 24× 6 quantity per tray = 144 PCS
Note: Please refer to the data from “estimated report about the dimension and stack of Carton “ about stacking carton

11. Precautions for Use of LCD Modules

11.1. Handling Precautions

- 11.1.1. The display panel is made of glass. Do not subject it to a mechanical shock by dropping it from a high place, etc.
- 11.1.2. If the display panel is damaged and the liquid crystal substance inside it leaks out, be sure not to get any in your mouth, if the substance comes into contact with your skin or clothes, promptly wash it off using soap and water.
- 11.1.3. Do not apply excessive force to the display surface or the adjoining areas since this may cause the color tone to vary.
- 11.1.4. The polarizer covering the display surface of the LCD module is soft and easily scratched. Handle this polarizer carefully.
- 11.1.5. If the display surface is contaminated, breathe on the surface and gently wipe it with a soft dry cloth. If still not completely clear, moisten cloth with one of the following solvents:
 - Isopropyl alcohol
 - Ethyl alcohol

Solvents other than those mentioned above may damage the polarizer. Especially, do not use the following:

- Water
 - Ketone
 - Aromatic solvents
- 11.1.6. Do not attempt to disassemble the LCD Module.
 - 11.1.7. If the logic circuit power is off, do not apply the input signals.
 - 11.1.8. To prevent destruction of the elements by static electricity, be careful to maintain an optimum work environment.
 - 11.1.8.1 Be sure to ground the body when handling the LCD Modules.
 - 11.1.8.2 Tools required for assembly, such as soldering irons, must be properly ground.
 - 11.1.8.3 To reduce the amount of static electricity generated, do not conduct assembly and other work under dry conditions.
 - 11.1.8.4 The LCD Module is coated with a film to protect the display surface. Be care when peeling off this protective film since static electricity may be generated.

11.2. Storage precautions

- 11.1.1. When storing the LCD modules, avoid exposure to direct sunlight or to the light of fluorescent lamps.
- 11.1.2. The LCD modules should be stored under the storage temperature range. If the LCD modules will be stored for a long time, the recommend condition is:

Temperature : 0°C ~ 40°C Relatively humidity: ≤80%

- 11.1.3. The LCD modules should be stored in the room without acid, alkali and harmful gas.

11.3. Transportation Precautions

- 11.1.1. The LCD modules should be no falling and violent shocking during transportation, and also should avoid excessive press, water, damp and sunshine.

Our company network supports you worldwide with offices in Germany, Austria, Switzerland, the UK and the USA. For more information please contact:

Headquarters

Germany



FORTEC Elektronik AG

Augsburger Str. 2b
82110 Germering

Phone: +49 89 894363-0
E-Mail: sales@fortecag.de
Internet: www.fortecag.de

Fortec Group Members

Austria



FORTEC Elektronik AG

Office Vienna

Nuschinggasse 12
1230 Wien

Phone: +43 1 8673492-0
E-Mail: office@fortec.at
Internet: www.fortec.at

Germany



Distec GmbH

Augsburger Str. 2b
82110 Germering

Phone: +49 89 894363-0
E-Mail: info@distec.de
Internet: www.distec.de



FORTEC Elektronik AG

Lechwiesenstraße 9
86899 Landsberg am Lech

Phone: +49 8191 91172-0
E-Mail: sales@fortecag.de
Internet: www.fortecag.de

Switzerland



ALTRAC AG

Bahnhofstraße 3
5436 Würenlos

Phone: +41 44 7446111
E-Mail: info@altrac.ch
Internet: www.altrac.ch

United Kingdom



Display Technology Ltd.

Osprey House, 1 Osprey Court
Hichingbrooke Business Park
Huntingdon, Cambridgeshire, PE29 6FN

Phone: +44 1480 411600
E-Mail: info@displaytechnology.co.uk
Internet: www.displaytechnology.co.uk

USA



Apollo Display Technologies, Corp.

87 Raynor Avenue,
Unit 1 Ronkonkoma,
NY 11779

Phone: +1 631 5804360
E-Mail: info@apolloDisplays.com
Internet: www.apolloDisplays.com