



OUR GLOBAL  
COMPETENCE  
CENTRES

 APOLLO DISPLAY  
TECHNOLOGIES



 DISTEC



 DISPLAY  
TECHNOLOGY



# Datasheet

## **BOE**

### **EV240WUM-N10**

BO-01-013

**TITLE : EV240WUM-N10****Product Specification****Rev. 1****BEIJING BOE Display TECHNOLOGY CO. LTD**



## Contents

<b>No.</b>	<b>Item</b>	<b>Page</b>
1.0	General Description	4
2.0	Absolute Maximum Ratings	6
3.0	Electrical Specifications	7
4.0	Optical Specifications	9
5.0	Interface Connection	11
6.0	Signal Timing Specifications	14
7.0	Signal Timing Waveforms of Interface Signal	16
8.0	Input Signals, Display Colors & Gray Scale of Colors	18
9.0	Power Sequence	19
10.0	Mechanical Characteristics	20
11.0	Reliability Test	21
12.0	Handling& Cautions	22
13.0	Product Serial Number	23
14.0	Packing	24
15.0	Appendix	26

## 1.0 GENERAL DESCRIPTION

### 1.1 Introduction

EV240WUM-N10 is a color active matrix TFT LCD module using amorphous silicon TFT's (Thin Film Transistors) as an active switching devices. This module has a 24 inch diagonally measured active area with WUXGA resolutions (1920 horizontal by 1200 vertical pixel array). Each pixel is divided into RED, GREEN, BLUE dots which are arranged in vertical stripe and this module can display 16.7M colors. The TFT-LCD panel used for this module is adapted for a low reflection and higher color type.

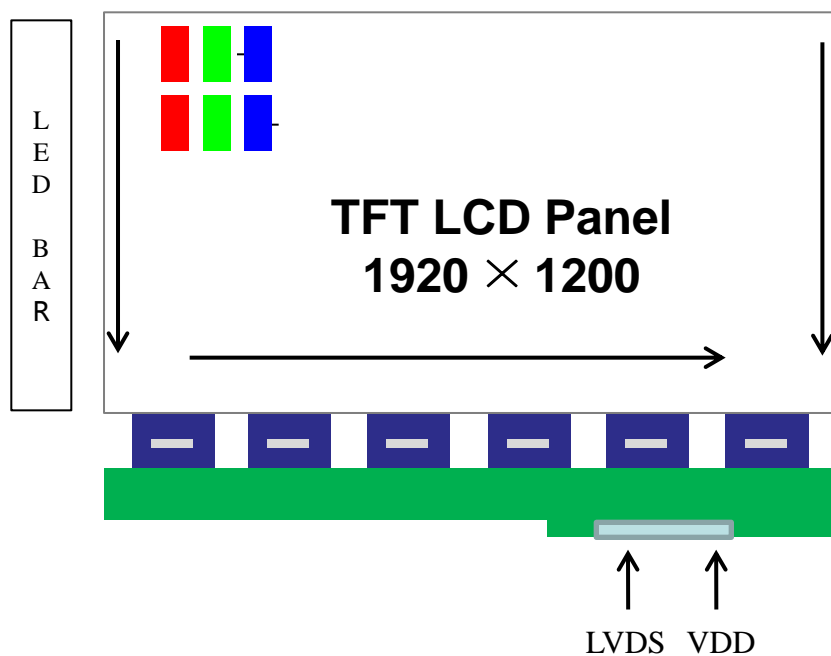

### 1.2 Features

- Real 8 bit color depth, display 16.7M colors
- Compatible with Color Gamut 72% @NTSC(CIE 1931)
- High luminance and contrast ratio, low reflection and wide viewing angle
- DE (Data Enable) only
- RoHS/Halogen Free
- Gamma Correction

### 1.3 Application

- Medical Use

### 1.4 General Specification

The followings are general specifications at the model MV240WUM-N10.

<Table 1. General Specifications>

Parameter	Specification	Unit	Remarks
Active area	518.4(H) × 324(V)	mm	
Number of pixels	1920(H) × 1200 (V)	pixels	
Pixel pitch	0.27 (H) × 0.27(V)	mm	
Pixel arrangement	RGB Vertical stripe		
Display colors	16.7M	colors	
Display mode	Normally Black		
Dimensional outline	546.4(H) × 352.0(V) × 11.7(Depth)	mm	Detail refer to drawing
Depth	11.7±0.5	mm	
Weight	2608 ± 150	g	
Bezel width (L/R/U/D)	12/11.4/12/12	mm	
Surface Treatment	Haze 25%, 3H		
Back-light	Right edge side, 1-LED Lighting Bar type		

## 2.0 ABSOLUTE MAXIMUM RATINGS

The followings are maximum values which, if exceed, may cause faulty operation or damage to the unit. The operational and non-operational maximum voltage and current values are listed in Table 2.

< Table 2. Absolute Maximum Ratings >

[VSS=GND=0V]

Parameter	Symbol	Min.	Max.	Unit	Remarks
Power Supply Voltage	$V_{DD}$	GND-0.3	6	V	Ta = 25 °C
Logic Supply Voltage	$V_{IN}$	VSS-0.3	$V_{DD}+0.3$	V	
Operating Temperature	$T_{OP}$	0	+50	°C	1)
Storage Temperature	$T_{ST}$	-20	+60	°C	1)

Note : 1) Temperature and relative humidity range are shown in the figure below.  
Wet bulb temperature should be 39 °C max. and no condensation of water.

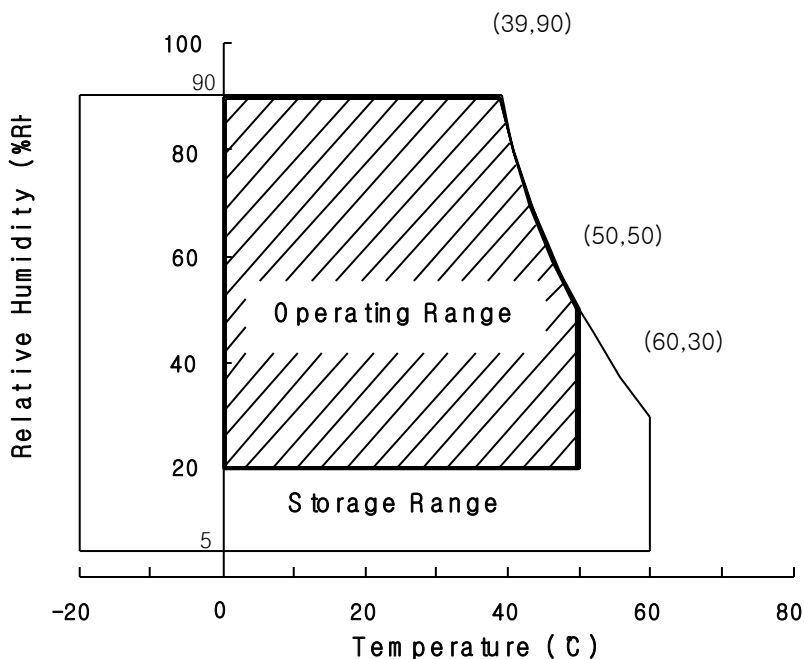



### 3.0 ELECTRICAL SPECIFICATIONS

#### 3.1 Electrical Specifications

< Table 3. Electrical specifications >

[Ta = 25 ± 2 °C]

Parameter		Min.	Typ.	Max.	Unit	Remarks
Power Supply Voltage	V <sub>DD</sub>	4.5	5	5.5	V	Note1
Power Supply Current	I <sub>DD</sub>	-	1300	2000	mA	
In-Rush Current	I <sub>RUSH</sub>	-	-	4.0	A	Note 2
Permissible Input Ripple Voltage	V <sub>RF</sub>	-	-	400	mV	Note1,3
High Level Differential Input Threshold Voltage	V <sub>IH</sub>	+100	-	+300	mV	
Low Level Differential Input Threshold Voltage	V <sub>IL</sub>	-300	-	-100	mV	
Differential input voltage	V <sub>ID</sub>	200	-	600	mV	
Differential input common mode voltage	V <sub>cm</sub>	1.0	1.2	1.5		V <sub>IH</sub> =100mV, V <sub>IL</sub> =-100mV
Power Consumption	P <sub>D</sub>	-	6.5	11	W	

- Notes : 1. The supply voltage is measured and specified at the interface connector of LCM.  
 The current draw and power consumption specified is for VDD=5.0V, Frame rate=60Hz  
 Clock frequency =81.9MHz. Test Pattern of power supply current  
 a) Typ : Color Test  
 b) Max : V-Linesubline255

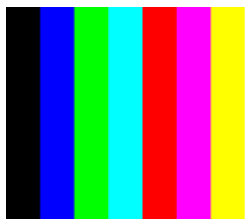

(a)

(b)

- Duration of rush current is about 2 ms and rising time of VDD is 520 μs ± 20 %
- Ripple Voltage should be covered by Input voltage Spec.
- Calculated value for reference (Input pins\*VPIN ×IPIN) excluding inverter loss.

**3.2 Backlight Unit**

&lt; Table 4. LED Backlight Unit &gt;

Parameter		Min.	Typ.	Max.	Unit	Remarks
LED Light Bar Input Voltage Per Input Pin	VPIN	70	74	84	V	Duty 100%
LED Light Bar Input Current Per Input Pin	IPIN	-	80	-	-	Note1,2
LED Power Consumption	P <sub>BL</sub>	-	19.5	23	W	Note 3
LED Life-Time	-	50,000	-	-	Hrs	Note 4

LED bar consists of 39 LED packages,3 strings(parallel)13packages(serial)

Note1: There are one light bar ,and the specified current is input LED chip 100% duty current

Note2: The sense current of each input pin is 80mA

Note3:  $P_{BL}=3 \text{ Input pins} \times V_{PIN} \times I_{PIN}$

Note4: The lifetime is determined as the time at which luminance of LED become 50% of the initial brightness or not normal lighting at  $I_{PIN}=95\text{mA}$  on condition of continuous operating at  $25 \pm 2 \text{ }^\circ\text{C}$

## 4.0 OPTICAL SPECIFICATION

### 4.1 Overview

The test of Optical specifications shall be measured in a dark room (ambient luminance  $\leq 1$  lux and temperature =  $25 \pm 2^\circ\text{C}$ ) with the equipment of Luminance meter system (Goniometer system and TOPCONE PR730) and test unit shall be located at an approximate distance 50cm from the LCD surface at a viewing angle of  $\theta$  and  $\Phi$  equal to  $0^\circ$ . We refer to  $\theta_{\Phi=0}$  ( $=\theta_3$ ) as the 3 o'clock direction (the "right"),  $\theta_{\Phi=90}$  ( $=\theta_{12}$ ) as the 12 o'clock direction ("upward"),  $\theta_{\Phi=180}$  ( $=\theta_9$ ) as the 9 o'clock direction ("left") and  $\theta_{\Phi=270}$  ( $=\theta_6$ ) as the 6 o'clock direction ("bottom"). While scanning  $\theta$  and/or  $\Phi$ , the center of the measuring spot on the Display surface shall stay fixed. The measurement shall be executed after 30 minutes warm-up period. VDD shall be 5.0V +/-10% at  $25^\circ\text{C}$ . Optimum viewing angle direction is 6 o'clock.

### 4.2 Optical Specifications

[VDD = 5.0V, Frame rate = 60Hz, Clock = 81.9MHz,  $I_{BL} = 240\text{mA}$ ,  $T_a = 25 \pm 2^\circ\text{C}$ ]  
< Table 5. Module Optical >

Parameter		Symbol	Condition	Min.	Typ.	Max.	Unit	Remark
Viewing Angle range	Horizontal	$\theta_3$	CR > 10	85	89	-	Deg.	Note 1
		$\theta_9$		85	89	-	Deg.	
	Vertical	$\theta_{12}$		85	89	-	Deg.	
		$\theta_6$		85	89	-	Deg.	
Luminance Contrast ratio		CR		800	1000			Note 2
Luminance of White		$Y_w$		500	600		cd/m <sup>2</sup>	Note 3
White luminance uniformity		$\Delta Y$		75	80		%	Note 4
Reproduction of color	White	$W_x$	$\theta = 0^\circ$ (Center) Normal Viewing Angle	0.270	0.300	0.330	-	Note 5
		$W_y$		0.285	0.315	0.345	-	
	Red	$R_x$		0.609	0.639	0.669	-	
		$R_y$		0.303	0.333	0.363	-	
	Green	$G_x$		0.29	0.320	0.35	-	
		$G_y$		0.593	0.623	0.653	-	
	Blue	$B_x$		0.121	0.151	0.181	-	
		$B_y$		0.018	0.048	0.078	-	
Response Time	GTG	$T_g$			14	20	ms	Note 6
Cross Talk		CT		-	-	2.0	%	Note 7

**Note :**

1. Viewing angle is the angle at which the contrast ratio is greater than 10. The viewing are determined for the horizontal or 3, 9 o'clock direction and the vertical or 6, 12 o'clock direction with respect to the optical axis which is normal to the LCD surface.
2. Contrast measurements shall be made at viewing angle of  $\theta = 0^\circ$  and at the center of the LCD surface. Luminance shall be measured with all pixels in the view field set first to white, then to the dark (black) state. (See FIGURE 1 shown in Appendix) Luminance Contrast Ratio (CR) is defined mathematically.

$$CR = \frac{\text{Luminance when displaying a white raster}}{\text{Luminance when displaying a black raster}}$$

3. Center Luminance of white is defined as the LCD surface. Luminance shall be measured with all pixels in the view field set first to white. This measurement shall be taken at the locations shown in FIGURE 2 for a total of the measurements per display.
4. The White luminance uniformity on LCD surface is then expressed as :  
 $\Delta Y = (\text{Minimum Luminance of 9points} / \text{Maximum Luminance of 9points}) * 100$   
 (See FIGURE 2 shown in Appendix).
5. The color chromaticity coordinates specified in Table 5. shall be calculated from the spectral data measured with all pixels first in red, green, blue and white. Measurements shall be made at the center of the panel.
6. Response time Tg is the average time required for display transition by switching the input signal as below table and is based on Frame rate fV =60Hz to optimize.  
 Each time in below table is defined as appendix Figure 3 and shall be measured by switching the input signal for "any level of gray(bright)" and "any level of gray(dark)"
7. Cross-Talk of one area of the LCD surface by another shall be measured by comparing the luminance ( $Y_A$ ) of a 25mm diameter area, with all display pixels set to a gray level, to the luminance ( $Y_B$ ) of that same area when any adjacent area is driven dark. (See FIGURE 4 shown in Appendix).

### 5.0 INTERFACE CONNECTION.

#### 5.1 Electrical Interface Connection

##### 5.1.1 LED Light Bar

-LED connector : 3707K-S06N-01L manufactured by ENTERY , or Equivalent.

< Table 6. LED Light Bar >

Pin No.	Symbol	Description
1	FB1	Channel 1 Current Feedback
2	NC	No Connection
3	VLED	LED Power Supply
4	VLED	LED Power Supply
5	FB2	Channel 2 Current Feedback
6	FB3	Channel 3 Current Feedback

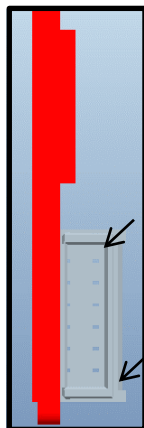

Pin1

Pin6

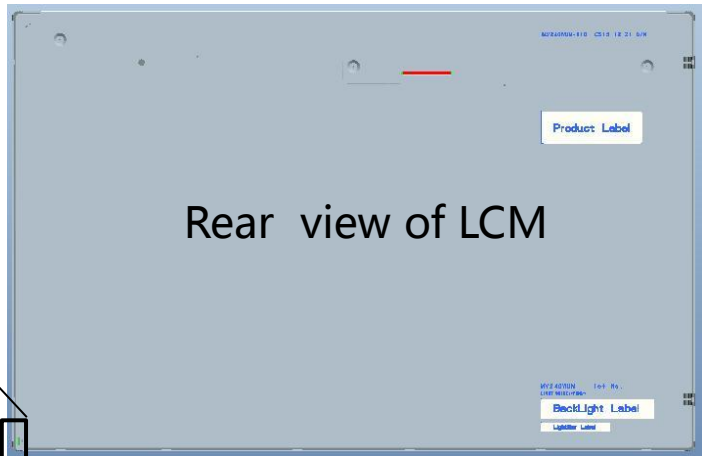

Rear view of LCM

## 5.0 INTERFACE CONNECTION.

### 5.1 Electrical Interface Connection

#### 5.1.2 LVDS Connector

- CN1 Module Side Connector : IS100-L300-C23

Pin No	Symbol	Function	Remark
1	RX00N	Negative LVDS differential data input	
2	RX00P	Positive LVDS differential data input	
3	RX01N	Negative LVDS differential data input	
4	RX01P	Positive LVDS differential data input	
5	RX02N	Negative LVDS differential data input	
6	RX02P	Positive LVDS differential data input	
7	GND	Ground	Note 1
8	RXOCN-	Negative LVDS differential clock input	
9	RXOCP	Positive LVDS differential clock input	
10	RX03N	Negative LVDS differential data input	
11	RX03P	Positive LVDS differential data input	
12	RXE0N	Negative LVDS differential data input	
13	RXE0P	Positive LVDS differential data input	
14	GND	Ground	
15	RXE1N	Negative LVDS differential data input	
16	RXE1P	Positive LVDS differential data input	
17	GND	Ground	
18	RXE2N	Negative LVDS differential data input	
19	RXE2P	Positive LVDS differential data input	
20	RXECN	Negative LVDS differential clock input	
21	RXECP	Positive LVDS differential clock input	
22	RXE3N	Negative LVDS differential data input	
23	RXE3P	Positive LVDS differential data input	
24	GND	Ground	
25	SDA	I2C Data (For VCOM tuning )	
26	SCL	I2C Clock (For VCOM tuning)	
27	NC	NC	
28	VIN	Power Supply 5V	
29	VIN	Power Supply 5V	
30	VIN	Power Supply 5V	

Note1: The Function of Bist backup , H or NC Bist on , L Bist off.

### 5.2 LVDS Interface (Tx; THC63LVDF83A or Equivalent)

#### 5.2.1 LVDS Interface

	Input Signal	Transmitter		Interface		HR230WU-400 (CN11)	Remark
		Pin No.	Pin No.	System (Tx)	TFT-LCD (Rx)	Pin No.	
LVDS	OR0	51	48 47	OUT0- OUT0+	RX00- RX00+	1	
	OR1	52					
	OR2	54					
	OR3	55					
	OR4	56					
	OR5	3					
	OG0	4	46 45	OUT1- OUT1+	RX01- RX01+	3	
	OG1	6					
	OG2	7					
	OG3	11					
	OG4	12					
	OG5	14					
	OB0	15	42 41	OUT2- OUT2+	RX02- RX02+	5	
	OB1	19					
	OB2	20					
	OB3	22					
	OB4	23					
	OB5	24					
	Hsync	27	40 39	CLK OUT- CLK OUT+	RXO CLK- RXO CLK+	8	
	Vsync	28					
DE	30	38 37	OUT3- OUT3+	RX03- RX03+	10		
MCLK	31						
OR6	50	10	11				
OR7	2						
OG6	8	16	18				
OG7	10						
OB6	16	25					
OB7	18						
RSVD	25						

Note: The order of even data is same with old data.

**6.0 SIGNAL TIMING SPECIFICATION**

6.1 The EV240WUM-N10 is operated by the DE only.

Item	Symbols		Min	Typ	Max	Unit	Note
DCLK	Period	tCLK	11.8	12.1	13.05	ns	
	Frequency	fCLK	76.57	81.972	84.5	MHz	
Hsync	Period	tHP	1050	1100	1120	tCLK	
	Horizontal Valid	tHV	960	960	960	tCLK	
	Horizontal Blank	tHB	90	140	160	tCLK	tWH+tHBP+tHFP
	Frequency	fH	-	74.52	-	KHz	
	Width	tWH	32	32	32	tCLK	
	Horizontal Back Porch	tHBP	28	50	60		
	Horizontal Front Porch	tHFP	30	58	68		
Vsync	Period	tVP	1236	1242	1248	tHP	
	Vertical Valid	tVV	1200	1200	1200	tHP	
	Vertical Blank	tVB	36	42	48	tHP	tWV+tVBP+tVFP
	Frequency	fV	59	60	61	Hz	
	Width	tWV	6	6	6	tHP	
	Vertical Back Porch	tVBP	27	33	39	tHP	
	Vertical Front Porch	tVFP	3	3	3	tHP	
LVDS Receiver clock	Input spread spectrum ratio	SSr	-3	-	+3	%	



### 6.2 LVDS Rx Interface Timing Parameter

The specification of the LVDS Rx interface timing parameter is shown in Table 7.

<Table 7. LVDS Rx Interface Timing Specification>

Item	Symbol	Min	Typ	Max	Unit	Remark
CLKIN Period	tRCIP	11.8	12.1	13.05	nsec	
Input Data 0	tRIP1	-0.4	0.0	+0.4	nsec	
Input Data 1	tRIP0	tRCIP/7-0.4	tRCIP/7	tRCIP/7+0.4	nsec	
Input Data 2	tRIP6	2 × tRCIP/7-0.4	2 × tRCIP/7	2 × tRCIP/7+0.4	nsec	
Input Data 3	tRIP5	3 × tRCIP/7-0.4	3 × tRCIP/7	3 × tRCIP/7+0.4	nsec	
Input Data 4	tRIP4	4 × tRCIP/7-0.4	4 × tRCIP/7	4 × tRCIP/7+0.4	nsec	
Input Data 5	tRIP3	5 × tRCIP/7-0.4	5 × tRCIP/7	5 × tRCIP/7+0.4	nsec	
Input Data 6	tRIP2	6 × tRCIP/7-0.4	6 × tRCIP/7	6 × tRCIP/7+0.4	nsec	

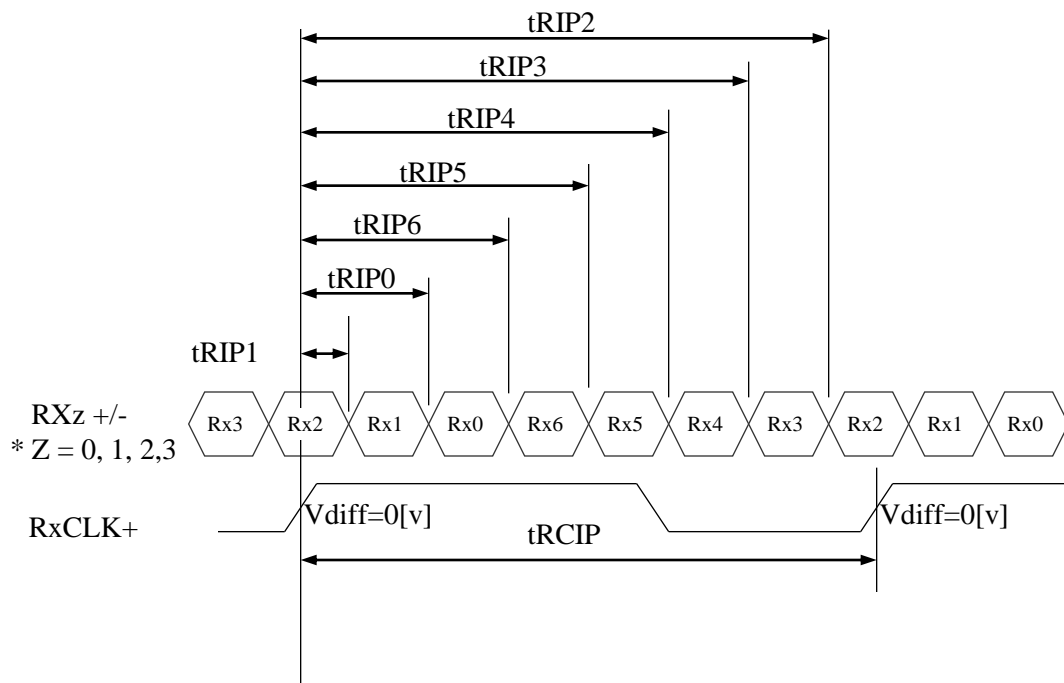

\*  $V_{diff} = (RX_{z+}) - (RX_{z-}), \dots, (RX_{CLK+}) - (RX_{CLK-})$

## 7.0 SIGNAL TIMING WAVEFORMS OF INTERFACE SIGNAL

### 7.1 Sync Timing Waveforms

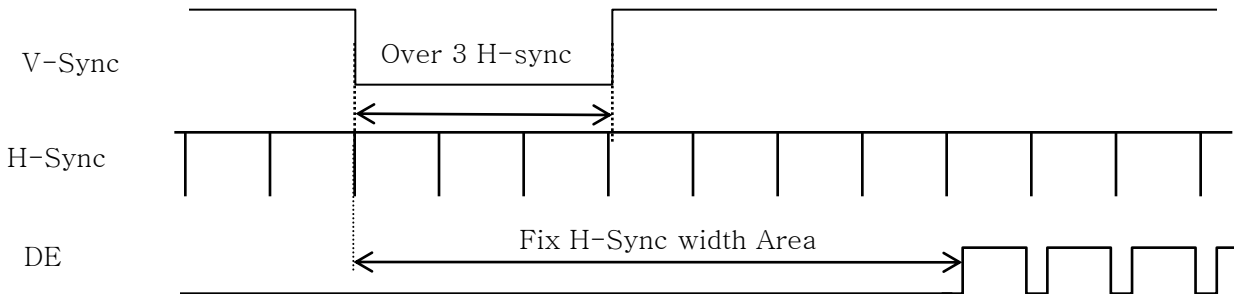

- 1) Need over 3 H-sync during V-Sync Low
- 2) Fix H-Sync width from V-Sync falling edge to first rising edge

### 7.2 Vertical Timing Waveforms

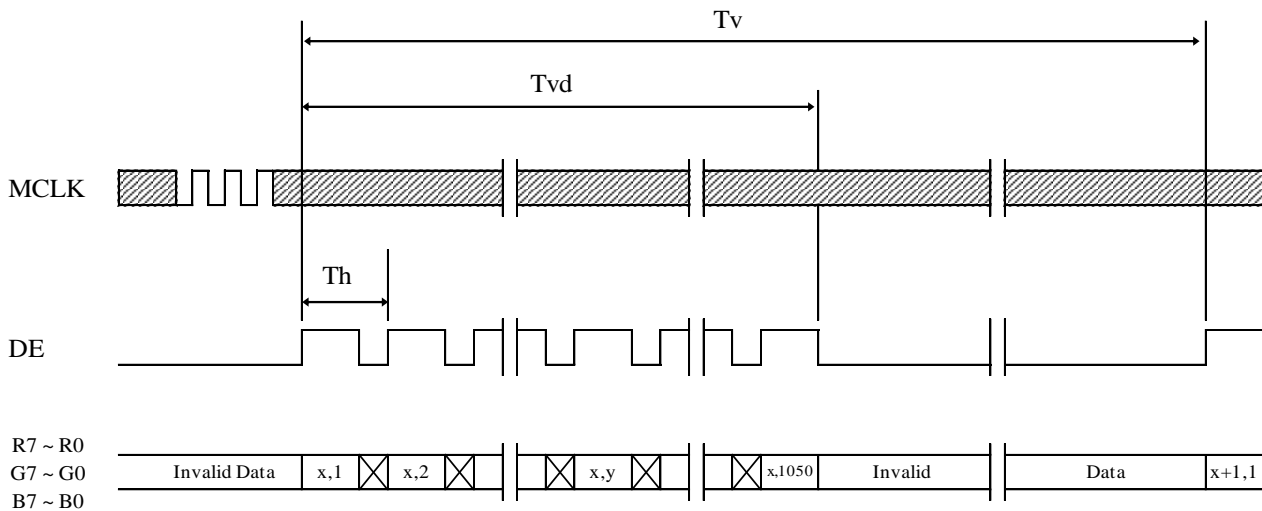

### 7.3 Horizontal Timing Waveforms

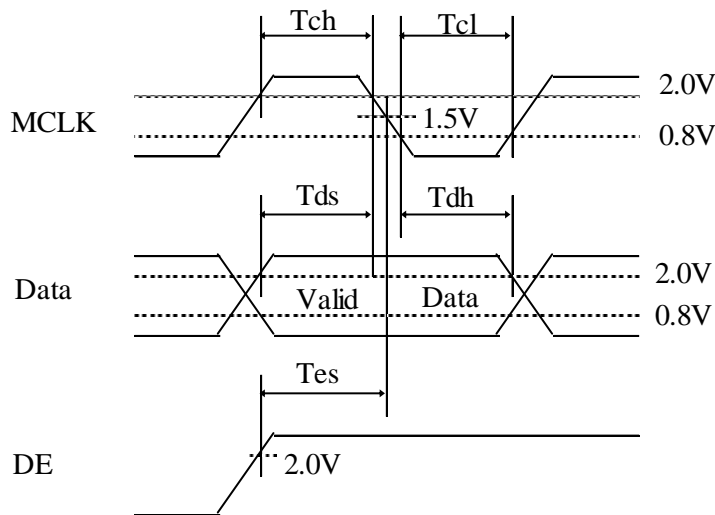
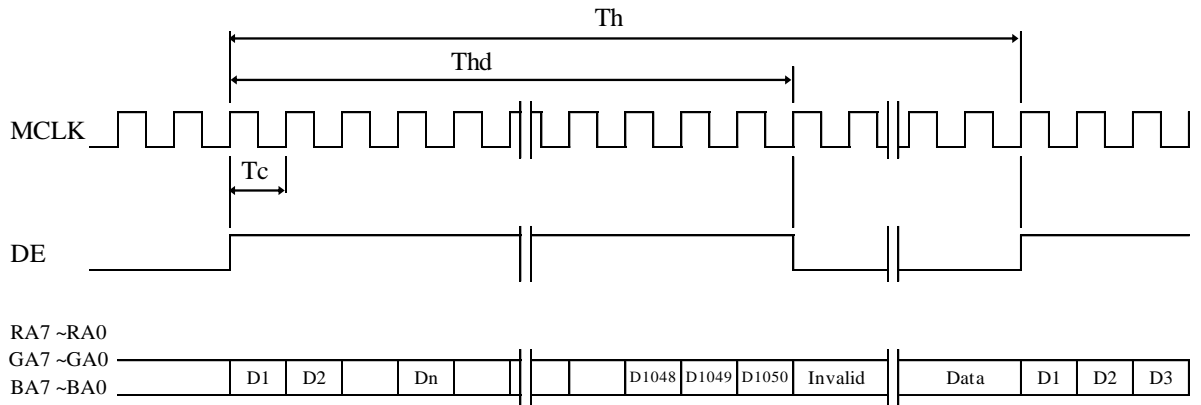

## 8.0 INPUT SIGNALS, BASIC DISPLAY COLORS & GRAY SCALE OF COLORS

Color & Gray Scale		RED DATA								GREEN DATA								BLUE DATA							
		R7	R6	R5	R4	R3	R2	R1	R0	G7	G6	G5	G4	G3	G2	G1	G0	B7	B6	B5	B4	B3	B2	B1	B0
Basic Colors	Black	0	0	0	0	0	0	0	0	0	0	0	0	0	0	0	0	0	0	0	0	0	0	0	0
	Blue	0	0	0	0	0	0	0	0	0	0	0	0	0	0	0	0	1	1	1	1	1	1	1	1
	Green	0	0	0	0	0	0	0	0	1	1	1	1	1	1	1	1	0	0	0	0	0	0	0	0
	Cyan	0	0	0	0	0	0	0	0	1	1	1	1	1	1	1	1	1	1	1	1	1	1	1	1
	Red	1	1	1	1	1	1	1	1	0	0	0	0	0	0	0	0	0	0	0	0	0	0	0	0
	Magenta	1	1	1	1	1	1	1	1	0	0	0	0	0	0	0	0	1	1	1	1	1	1	1	1
	Yellow	1	1	1	1	1	1	1	1	1	1	1	1	1	1	1	1	0	0	0	0	0	0	0	0
	White	1	1	1	1	1	1	1	1	1	1	1	1	1	1	1	1	1	1	1	1	1	1	1	1
Gray Scale of RED	Black	0	0	0	0	0	0	0	0	0	0	0	0	0	0	0	0	0	0	0	0	0	0	0	0
	△	0	0	0	0	0	0	0	1	0	0	0	0	0	0	0	0	0	0	0	0	0	0	0	0
	Darker	0	0	0	0	0	0	1	0	0	0	0	0	0	0	0	0	0	0	0	0	0	0	0	0
	△	↑								↑								↑							
	▽	↓								↓								↓							
	Brighter	1	1	1	1	1	1	0	1	0	0	0	0	0	0	0	0	0	0	0	0	0	0	0	0
	▽	1	1	1	1	1	1	1	0	0	0	0	0	0	0	0	0	0	0	0	0	0	0	0	0
	Red	1	1	1	1	1	1	1	1	0	0	0	0	0	0	0	0	0	0	0	0	0	0	0	0
Gray Scale of GREEN	Black	0	0	0	0	0	0	0	0	0	0	0	0	0	0	0	0	0	0	0	0	0	0	0	0
	△	0	0	0	0	0	0	0	0	0	0	0	0	0	0	0	1	0	0	0	0	0	0	0	0
	Darker	0	0	0	0	0	0	0	0	0	0	0	0	0	0	1	0	0	0	0	0	0	0	0	0
	△	↑								↑								↑							
	▽	↓								↓								↓							
	Brighter	0	0	0	0	0	0	0	0	1	1	1	1	1	1	0	1	0	0	0	0	0	0	0	0
	▽	0	0	0	0	0	0	0	0	1	1	1	1	1	1	1	0	0	0	0	0	0	0	0	0
	Green	0	0	0	0	0	0	0	0	1	1	1	1	1	1	1	1	0	0	0	0	0	0	0	0
Gray Scale of BLUE	Black	0	0	0	0	0	0	0	0	0	0	0	0	0	0	0	0	0	0	0	0	0	0	0	0
	△	0	0	0	0	0	0	0	0	0	0	0	0	0	0	0	0	0	0	0	0	0	0	0	1
	Darker	0	0	0	0	0	0	0	0	0	0	0	0	0	0	0	0	0	0	0	0	0	0	1	0
	△	↑								↑								↑							
	▽	↓								↓								↓							
	Brighter	0	0	0	0	0	0	0	0	0	0	0	0	0	0	0	0	1	1	1	1	1	1	0	1
	▽	0	0	0	0	0	0	0	0	0	0	0	0	0	0	0	0	1	1	1	1	1	1	1	0
	Blue	0	0	0	0	0	0	0	0	0	0	0	0	0	0	0	0	1	1	1	1	1	1	1	1
Gray Scale of WHITE	Black	0	0	0	0	0	0	0	0	0	0	0	0	0	0	0	0	0	0	0	0	0	0	0	0
	△	0	0	0	0	0	0	0	1	0	0	0	0	0	0	0	1	0	0	0	0	0	0	0	1
	Darker	0	0	0	0	0	0	1	0	0	0	0	0	0	0	1	0	0	0	0	0	0	0	1	0
	△	↑								↑								↑							
	▽	↓								↓								↓							
	Brighter	1	1	1	1	1	1	0	1	1	1	1	1	1	1	0	1	1	1	1	1	1	1	0	1
	▽	1	1	1	1	1	1	1	0	1	1	1	1	1	1	1	0	1	1	1	1	1	1	1	0
	White	1	1	1	1	1	1	1	1	1	1	1	1	1	1	1	1	1	1	1	1	1	1	1	1

## 9.0 POWER SEQUENCE

To prevent a latch-up or DC operation of the LCD module, the power on/off sequence shall be as shown in below

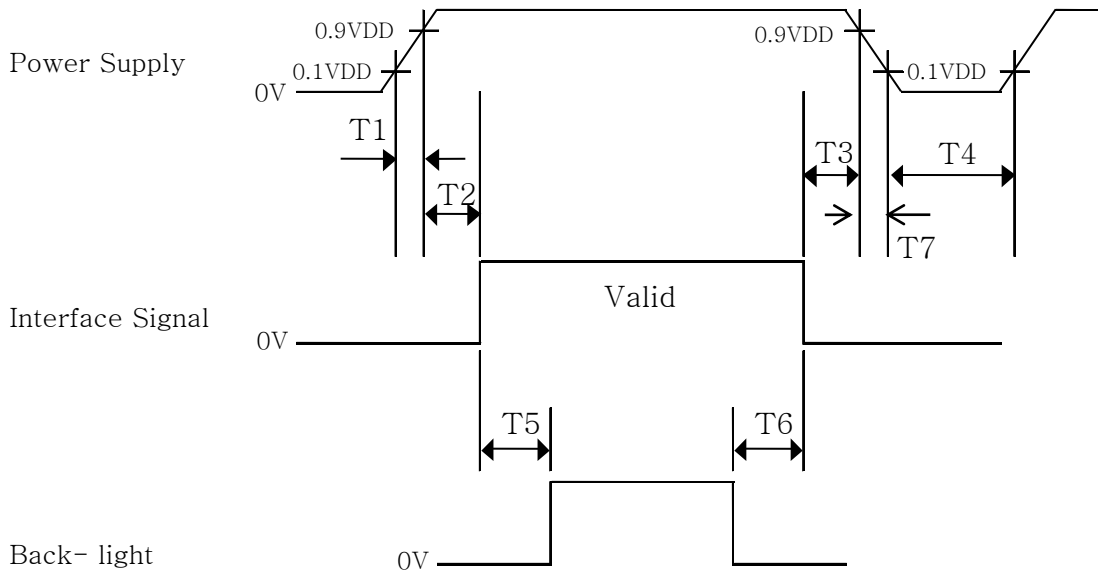

- $0.5 \text{ ms} \leq T1 \leq 10 \text{ ms}$
- $0 \leq T2 \leq 50 \text{ ms}$
- $0 \leq T3 \leq 50 \text{ ms}$
- $1 \text{ sec} \leq T4$
- $200 \text{ ms} \leq T5$
- $200 \text{ ms} \leq T6$

### Notes:

1. When the power supply VDD is 0V, keep the level of input signals on the low or keep high impedance.
2. Do not keep the interface signal high impedance when power is on.
3. Back Light must be turn on after power for logic and interface signal are valid.
4. T7 decreases smoothly, there is none re-bouncing voltage.

## 10.0 MECHANICAL CHARACTERISTICS

### 10.1 Dimensional Requirements

FIGURE 6 (located in Appendix) shows mechanical outlines for the model MV240WUM-N10. Other parameters are shown in Table 8.

<Table 8. Dimensional Parameters>

Parameter	Specification	Unit
Dimensional outline	546.4(H) × 352.0(V)	mm
Depth	11.7 ± 0.5	mm
Weight	2608 ± 150	gram
Active area	518.4(H) × 324(V)	mm
Pixel pitch	0.27 (H) × 0.27(V)	mm
Number of pixels	1920(H) × 1200 (V) (1 pixel = R + G + B dots)	pixels
Back-light	Right edge side, 1-LED Lighting Bar type	

### 10.2 Mounting

See FIGURE 5. (shown in Appendix)

### 10.3 Anti-Glare and Polarizer Hardness.

The surface of the LCD has an anti-glare coating to minimize reflection and a coating to reduce scratching.

### 10.4 Light Leakage

There shall not be visible light from the back-lighting system around the edges of the screen as seen from a distance 50cm from the screen with an overhead light level of 350lux.

**11.0 RELIABILITY TEST**

The Reliability test items and its conditions are shown in below.

<Table 9 Reliability Test Parameters >

No	Test Items	Conditions	
1	High temperature storage test	Ta = 60 °C, 240 hrs	
2	Low temperature storage test	Ta = -20 °C, 240 hrs	
3	High temperature & high humidity operation test	Ta = 50 °C, 80%RH, 240hrs	
4	High temperature operation test	Ta = 50 °C, 240hrs	
5	Low temperature operation test	Ta = 0°C, 240hrs	
6	Thermal shock	Ta = -20 °C ↔ 60 °C (0.5 hr), 100 cycle	
7	Vibration test (non-operating)	Frequency	Random, 10 ~ 300 Hz, 30 min/Axis
		Gravity / AMP	1.5 Grms
		Period	X, Y, Z 30 min
8	Shock test (non-operating)	Gravity	50G
		Pulse width	11msec, Half sine wave
		Direction	± X, ± Y, ± Z Once for each
9	Electro-static discharge test	Air : 150 pF, 330Ω, 15 KV	Contact : 150 pF, 330Ω, 8 KV

## 12.0 HANDLING & CAUTIONS

### (1) Cautions when taking out the module

- Pick the pouch only, when taking out module from a shipping package.

### (2) Cautions for handling the module

- As the electrostatic discharges may break the LCD module, handle the LCD module with care. Peel a protection sheet off from the LCD panel surface as slowly as possible.
- As the LCD panel and back - light element are made from fragile glass material, impulse and pressure to the LCD module should be avoided.
- As the surface of the polarizer is very soft and easily scratched, use a soft dry cloth without chemicals for cleaning.
- Do not pull the interface connector in or out while the LCD module is operating.
- Put the module display side down on a flat horizontal plane.
- Handle connectors and cables with care.

### (3) Cautions for the operation

- When the module is operating, do not lose CLK, ENAB signals. If any one of these signals is lost, the LCD panel would be damaged.
- Obey the supply voltage sequence. If wrong sequence is applied, the module would be damaged.

### (4) Cautions for the atmosphere

- Dew drop atmosphere should be avoided.
- Do not store and/or operate the LCD module in a high temperature and/or humidity atmosphere. Storage in an electro-conductive polymer packing pouch and under relatively low temperature atmosphere is recommended.

### (5) Cautions for the module characteristics

- Do not apply fixed pattern data signal to the LCD module at product aging.
- Applying fixed pattern for a long time may cause image sticking.

### (6) Other cautions

- Do not disassemble and/or re-assemble LCD module.
- Do not re-adjust variable resistor or switch etc.
- When returning the module for repair or etc., Please pack the module not to be broken. We recommend to use the original shipping packages.



### 13.0 PRODUCT SERIAL NUMBER

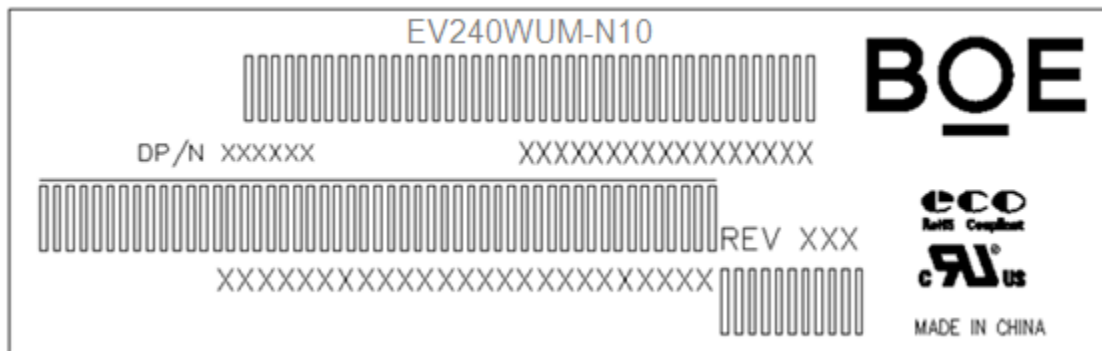

#### MDL ID Naming Rule:

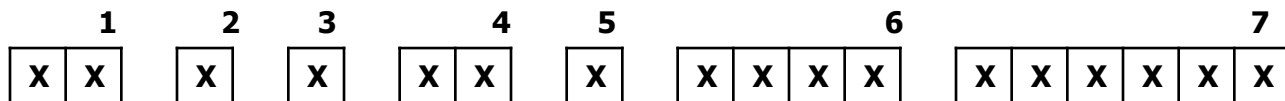

1. Control Number

2. Rank / Grade

3. Line Classification

4. Year (2001 : 01, 2002 : 02, ...)

5. Month (1,2,3, ... , 9, X, Y, Z)

6. Internal Use

7. Serial Number

## 14.0 Packing

### 14.1 Packing Order

Put pad into the box



Place the modules bundled by packing bag into the box, 8pcs module per box, put a cover on the top of the box

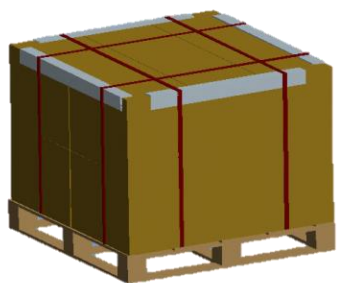

12ea box per pallet

After sealing the box, put the box on the pallet

### 14.2 Packing Note

- Box Dimension : 626mm(L)×304mm(W)×444mm(H)
- Package Quantity in one Box : 8pcs

### 14.3 Box label

- Label Size : 110 mm (L) × 55mm (W)
- Contents  
Model : EV240WUM-N10  
Q`ty : Module \* Q`ty in one box  
Serial No. : Box Serial No.  
Date : Packing Date

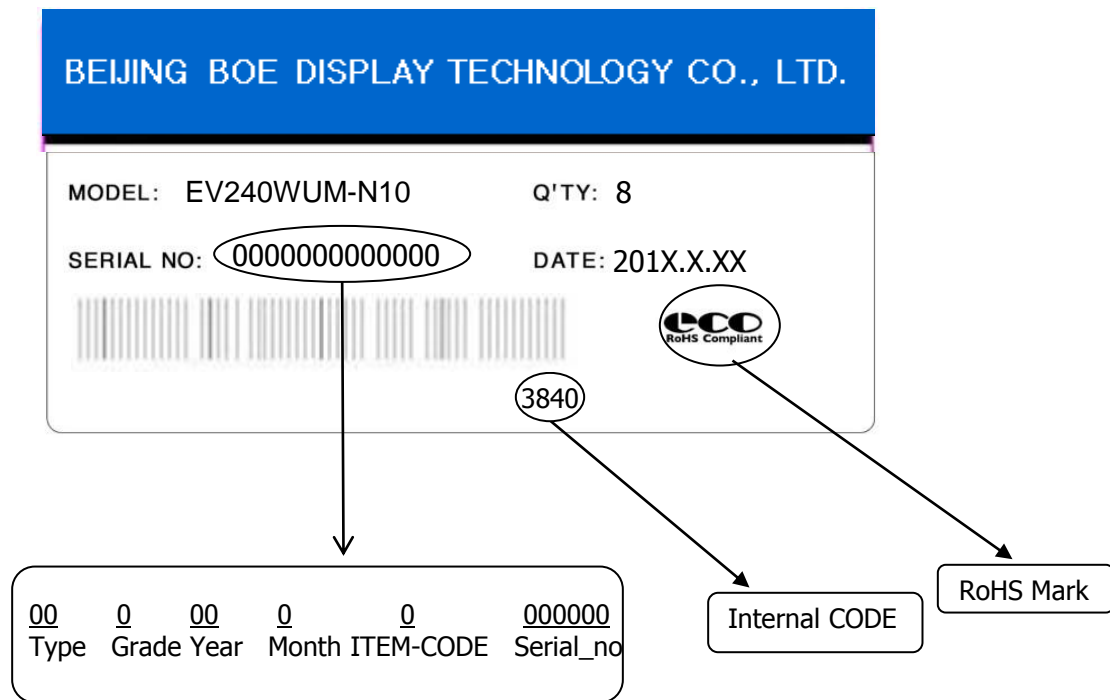

## 15.0 APPENDIX

**Figure 1. Measurement Set Up**

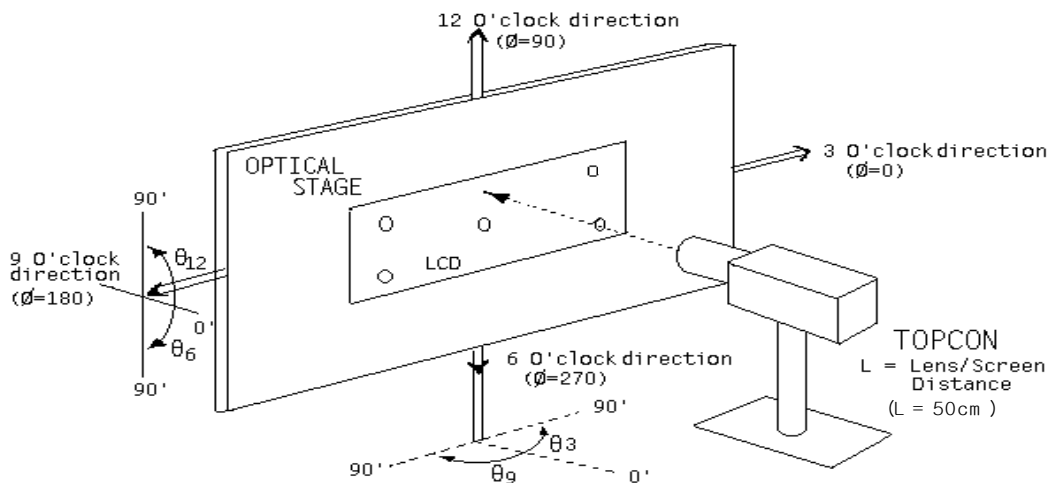

**Figure 2. White Luminance and Uniformity Measurement Locations (9 points)**

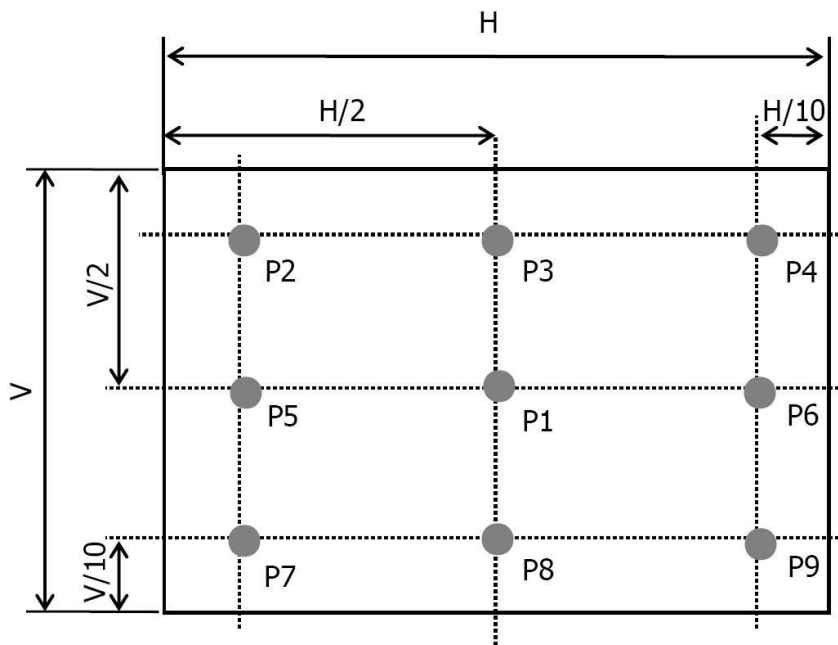

**Figure 3. Response Time Testing**

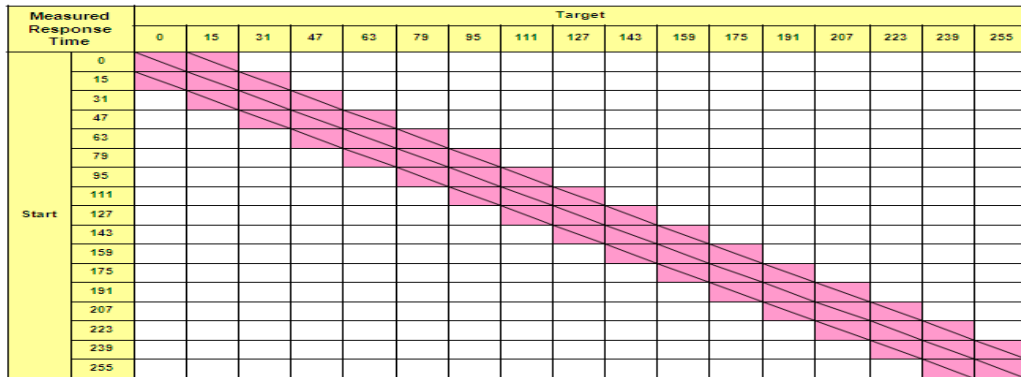

**Figure 4. Cross Modulation Test Description**

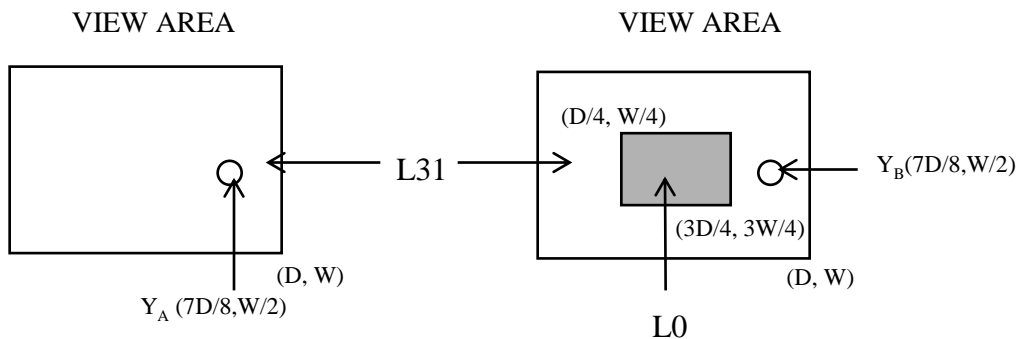

$$\text{Cross-Talk (\%)} = \left| \frac{Y_B - Y_A}{Y_A} \right| \times 100$$

Where:  $Y_A$  = Initial luminance of measured area (cd/m<sup>2</sup>)

$Y_B$  = Subsequent luminance of measured area (cd/m<sup>2</sup>)

The location measured will be exactly the same in both patterns

Figure 5. TFT-LCD Module Outline Dimensions (Front view)

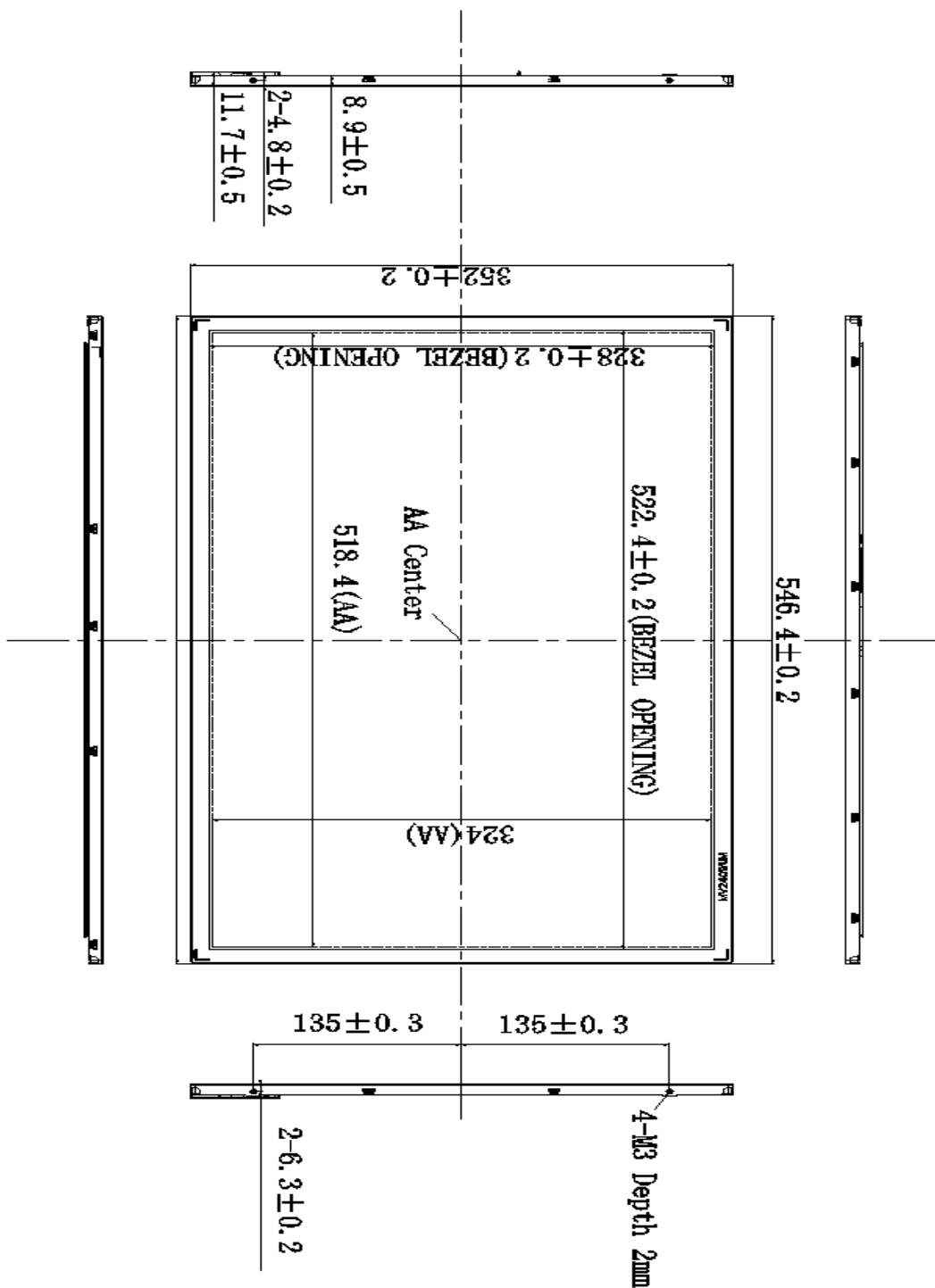

**Figure 6. TFT-LCD Module Outline Dimensions (Rear view)**

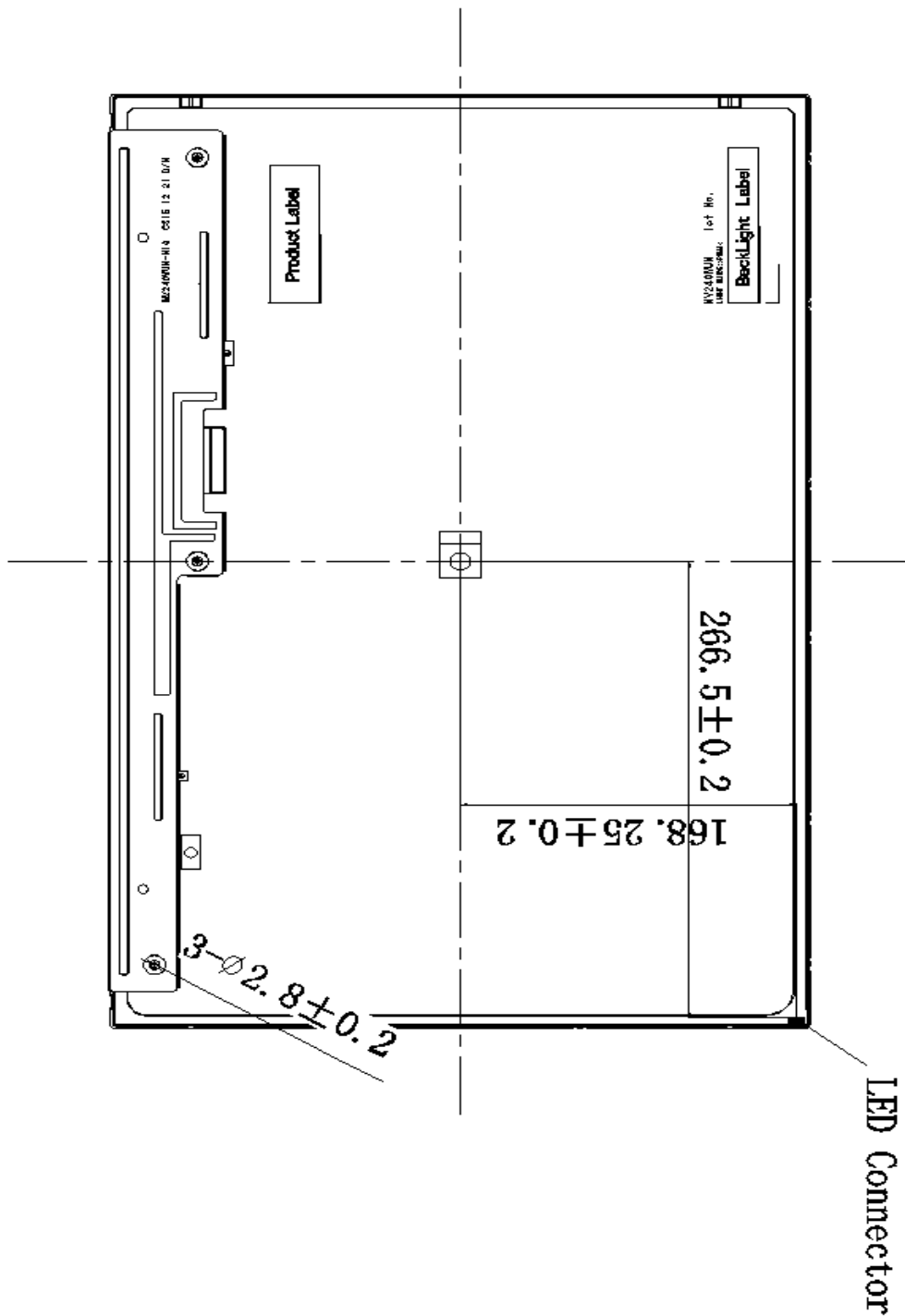

Our company network supports you worldwide with offices in Germany, Austria, Switzerland, the UK and the USA. For more information please contact:

## Headquarters

### Germany



#### FORTEC Elektronik AG

Augsburger Str. 2b  
82110 Germering

Phone: +49 89 894450-0  
E-Mail: [info@fortecag.de](mailto:info@fortecag.de)  
Internet: [www.fortecag.de](http://www.fortecag.de)

## Fortec Group Members

### Austria



#### Distec GmbH Office Vienna

Nuschinggasse 12  
1230 Wien

Phone: +43 1 8673492-0  
E-Mail: [info@distec.de](mailto:info@distec.de)  
Internet: [www.distec.de](http://www.distec.de)

### Germany



#### Distec GmbH

Augsburger Str. 2b  
82110 Germering

Phone: +49 89 894363-0  
E-Mail: [info@distec.de](mailto:info@distec.de)  
Internet: [www.distec.de](http://www.distec.de)

### Switzerland



#### ALTRAC AG

Bahnhofstraße 3  
5436 Würenlos

Phone: +41 44 7446111  
E-Mail: [info@altrac.ch](mailto:info@altrac.ch)  
Internet: [www.altrac.ch](http://www.altrac.ch)

### United Kingdom



#### Display Technology Ltd.

Osprey House, 1 Osprey Court  
Hichingbrooke Business Park  
Huntingdon, Cambridgeshire, PE29 6FN

Phone: +44 1480 411600  
E-Mail: [info@displaytechnology.co.uk](mailto:info@displaytechnology.co.uk)  
Internet: [www.displaytechnology.co.uk](http://www.displaytechnology.co.uk)

### USA



#### Apollo Display Technologies, Corp.

87 Raynor Avenue,  
Unit 1 Ronkonkoma,  
NY 11779

Phone: +1 631 5804360  
E-Mail: [info@apolloDisplays.com](mailto:info@apolloDisplays.com)  
Internet: [www.apolloDisplays.com](http://www.apolloDisplays.com)