



OUR GLOBAL
COMPETENCE
CENTRES

 APOLLO DISPLAY
TECHNOLOGIES



 DISTEC



 DISPLAY
TECHNOLOGY



Datasheet

Disea

ZW-T334TOS-01CP

DE-05-002



PRODUCT SPECIFICATIONS

For Customer: _____

: APPROVAL FOR SPECIFICATION

Customer Model No. _____

: APPROVAL FOR SAMPLE

Module No.: ZW-T334TOS-01CP

Date : 2017-05-25

Table of Contents

No.	Item	Page
1	Cover Sheet(Table of Contents)	
2	Revision Record	
3	General Specifications	
4	Outline Drawing	
5	Absolute Maximum Ratings	
6	Electrical Specifications	
7	Optical Characteristics	
8	CTP Parameters	
9	Reliability Test Items and Criteria	
10	Precautions for Use of LCD Modules	

For Customer's Acceptance:

Approved By	Comment

PREPARED	CHECKED	VERIFIED BY QA DEPT	VERIFIED BY R&D DEPT
john	Techshu		Dmjiaing

2. Revision Record

Date	Rev.No.	Page	Revision Items	Prepared
2017-05-25	V0		The first release	JOHN

3. General Specifications

ZW-T334TOS-01CP is a TFT-LCD module. It is composed of a TFT-LCD panel, driver IC, FPC, CTP and backlight unit. The 3.34'' round display area contains 320x320 pixels and can display up to 262K colors. This product accords with RoHS environmental criterion.

Item	Contents	Unit	Note
LCD Type	TFT/Transmissive/Normally white	-	
Display color	262K	-	
Viewing Direction	12:00	O'Clock	
Gray scale inversion direction	6:00	O'Clock	
Operating temperature	-20~+70	°C	
Storage temperature	-30~+80	°C	
Module size	81.8x81.8x3.84	mm	
Active Area(W×H)	60.0x60.0	mm	
Number of Dots	320×320	dots	
Controller	ST7796S	-	
Power Supply Voltage	2.8	V	
Backlight	6-LEDs (white)	pcs	
Weight	-	g	
Interface	1 Lane MIPI	-	

Note 1: Color tune is slightly changed by temperature and driving voltage.

Note 2: Without FPC and Solder.

4.Outline.Drawing

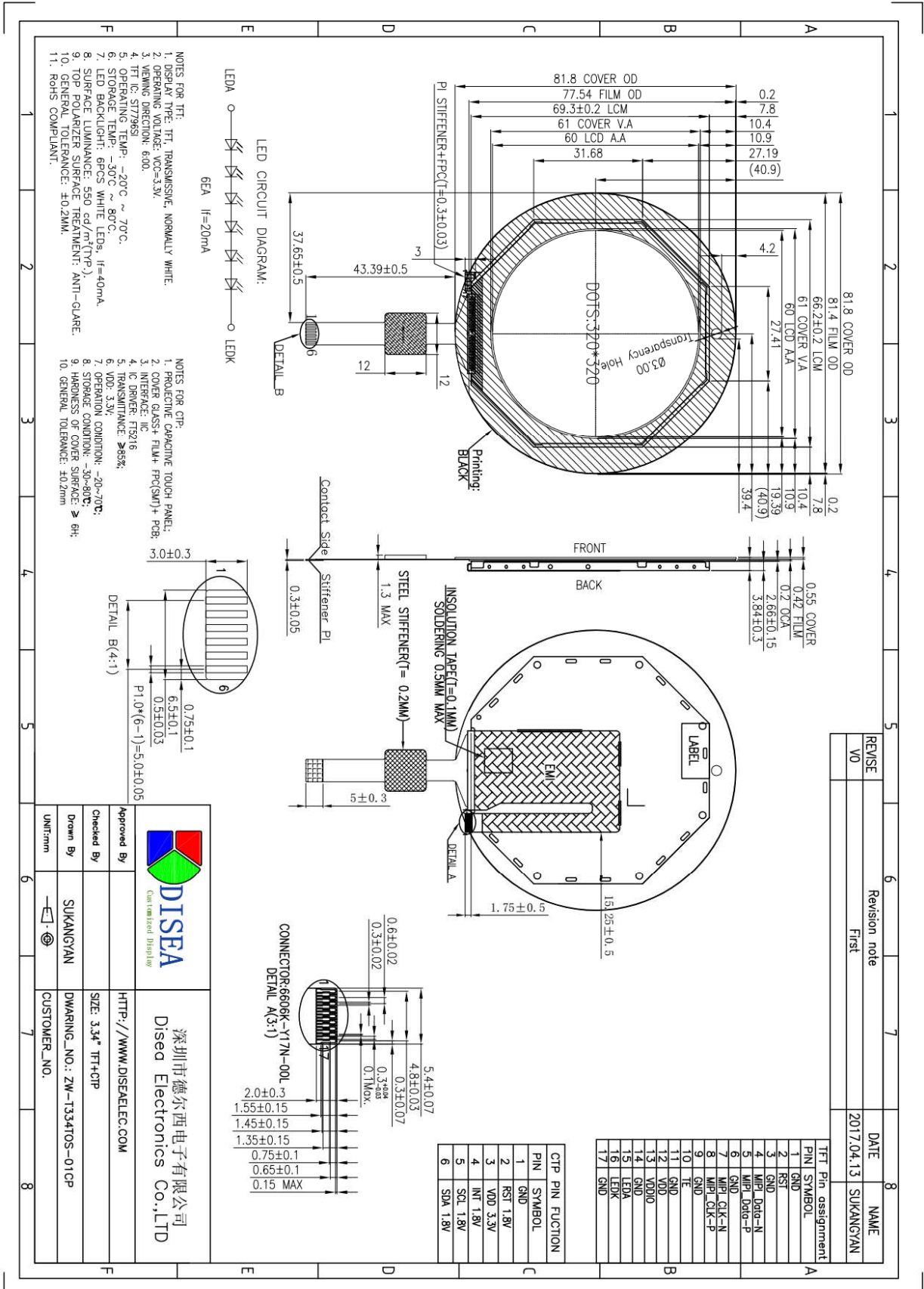

5. Absolute Maximum Ratings($T_a=25\text{ }^\circ\text{C}$)

5.1 Electrical Absolute Maximum Ratings.($V_{SS}=0\text{V}$, $T_a=25\text{ }^\circ\text{C}$)

Item	Symbol	Min.	Max.	Unit	Note
Power Supply Voltage	V_{CC}	-0.3	4.0	V	1,2
Logic Signal Input /Output Voltage	V_{DDIO}	-0.3	4.0	V	

Notes:

1. If the module is above these absolute maximum ratings. It may become permanently damaged. Using the module within the following electrical characteristic conditions are also exceeded, the module will malfunction and cause poor reliability.
2. $V_{CC} > V_{SS}$ must be maintained.
3. Please be sure users are grounded when handing LCD Module.

5.2 Environmental Absolute Maximum Ratings.

Item	Storage		Operating		Note
	MIN.	MAX.	MIN.	MAX.	
Ambient Temperature	-30 $^\circ\text{C}$	80 $^\circ\text{C}$	-20 $^\circ\text{C}$	70 $^\circ\text{C}$	1,2
Humidity	-	-	-	-	3

1. The response time will become lower when operated at low temperature.
2. Background color changes slightly depending on ambient temperature.
The phenomenon is reversible.
3. $T_a \leq 40\text{ }^\circ\text{C}$: 85%RH MAX.
 $T_a \geq 40\text{ }^\circ\text{C}$: Absolute humidity must be lower than the humidity of 85%RH at 40 $^\circ\text{C}$.

6. Electrical Specifications and Instruction Code

6.1 Electrical characteristics ($V_{SS}=0V, T_a=25^\circ C$)

Parameter	Symbol	Condition	Min	Typ	Max	Unit	Note
Power supply	VDD	$T_a=25^\circ C$	2.5	2.8	3.6	V	
Power supply	VDDIO	$T_a=25^\circ C$	1.65	2.8	3.6	V	
Input voltage	'H'	V_{IH}	0.7 V_{DDIO}	-	V_{DDIO}	V	
	'L'	V_{IL}	0	-	$0.3V_{DDIO}$	V	
Current Consumption	I_{CC1}	Normal mode	-	15	30	mA	1
	I_{CC2}	Sleep mode	-	0.05	0.1	mA	1

Note: 1: Tested in 1×1 chessboard pattern.

6.2 LED backlight specification ($V_{SS}=0V, T_a=25^\circ C$)

Item	Symbol	Condition	Min	Typ	Max	Unit	Note
Supply voltage	V_f	$I_f=20mA$	16.8	18	19.2	V	
Uniformity	ΔB_p	$I_f=20mA$	70	-	-	%	
Luminance for Module	L_v	$I_f=20mA$	450	550	-	Cd/m ²	
LED Life time	-	$I_f=20mA$	20k	-	-	Hours	

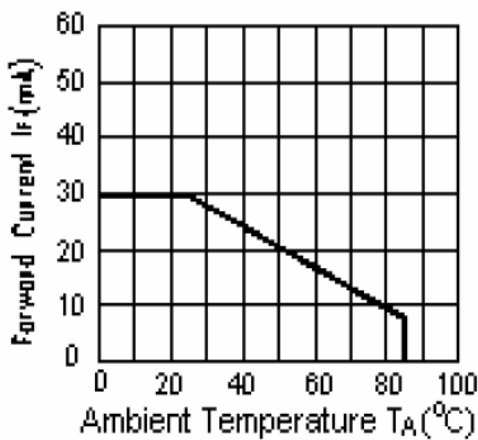

I_{LED} VS TEMP

6.3 Interface signals

Pin No.	Symbol	I/O	Function
1	GND	P	Ground
2	RST	I	Global reset signal
3	GND	P	Ground
4	MIPI_Data-N	I	MIPI Data
5	MIPI_Data-P	I	MIPI Data
6	GND	P	Ground
7	MIPI_CLK-N	I	MIPI Clock
8	MIPI_CLK-P	I	MIPI Clock
9	GND	P	Ground
10	TE	I	Tearing effect output
11	GND	P	Ground
12	VDD	P	Analog power supply
13	VDDIO	P	Digital power supply
14	GND	P	Ground
15	LEDA	P	LED Anode
16	LEDK	P	LED Cathode
17	GND	P	Ground

6.4 AC electrical characteristics

•AC characteristics timing table

High Speed Mode – Clock Channel Timing

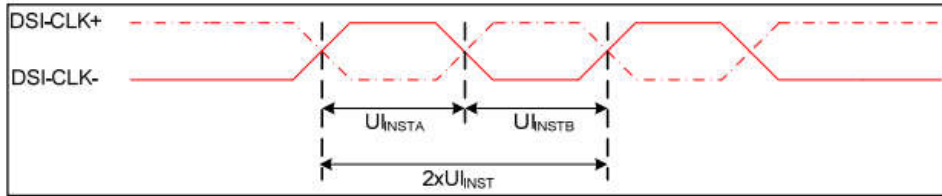

Signal	Symbol	Parameter	MIN	MAX	Unit	Description
DSI-DATA_P/N	2xUI INST	Double UI instantaneous	4	25	ns	
DSI-DATA_P/N	UI INSTA ,UI INSTB	UI instantaneous Half	2	12.5	ns	

High-Speed Data Transmission

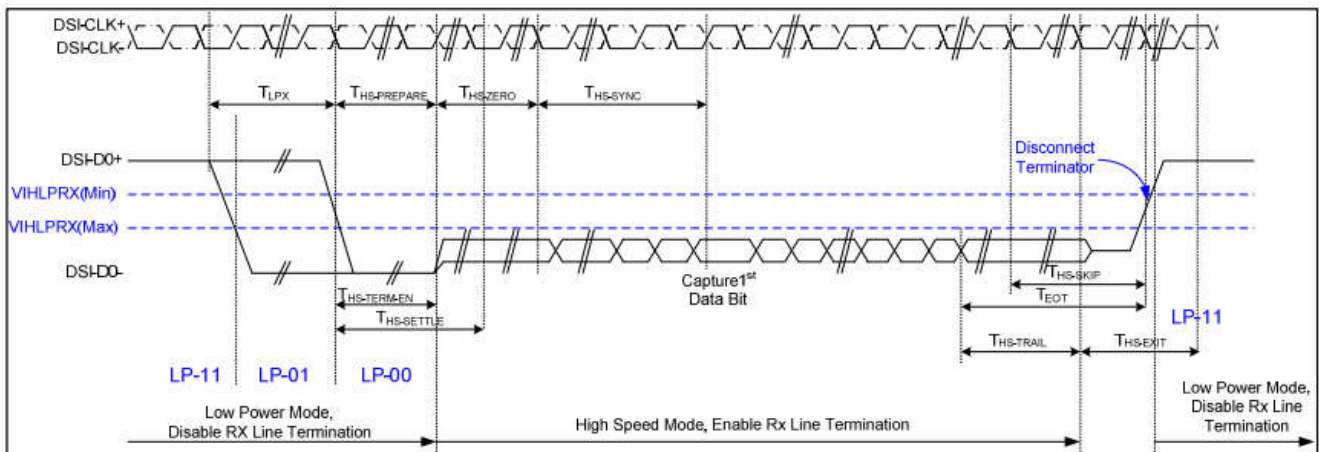

Parameter	Symbol	MIN	TYP	MAX	Unit
Time to drive LP-00 to prepare for HS transmission	$T_{HS-PREPARE}$	40+4UI		85+6UI	ns
Time from start of $t_{HS-TRAIL}$ or $t_{CLK-TRAIL}$ period to start of LP-11 state	T_{EOT}			105+12UI	ns
Time to enable data receiver line termination measured from when Dn crosses VILMAX	$T_{HS-TERM-EN}$			35+4UI	ns
Time to drive flipped differential state after last payload data bit of a HS transmission	$T_{HS-TRAIL}$	60+4UI			ns
Time-out at RX to ignore transition period of EoT	$T_{HS-SKIP}$	40		55+4UI	ns
Time to drive LP-11 after HS burst	$T_{HS-EXIT}$	100			ns
Length of any Low-Power state period	T_{LPX}	50			ns
Sync sequence period	$T_{HS-SYNC}$		8UI		ns
Minimum lead HS-0 drive period before the Sync sequence	$T_{HS-ZERO}$	105+6UI			ns

Switching the Clock Lane between Clock Transmission and Low-Power Mode

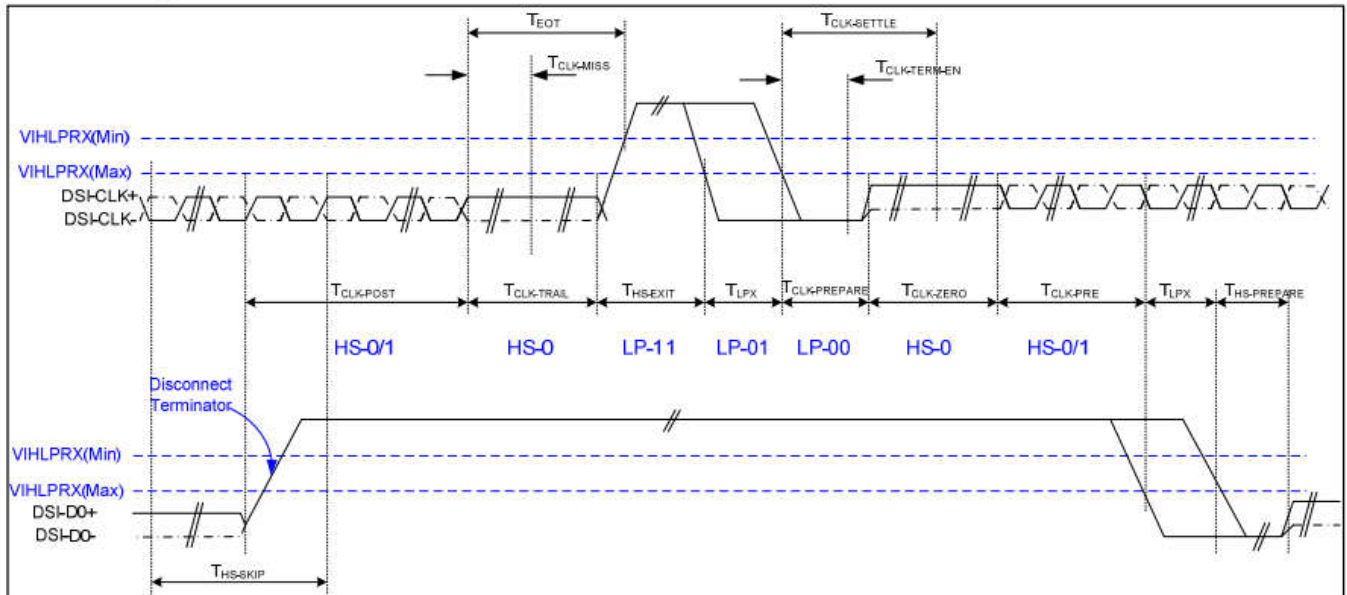

Parameter	Symbol	MIN	TYP	MAX	Unit
Time that the transmitter shall continue sending HS clock after the last associated Data Lane has transitioned to LP mode	$T_{CLK-POST}$	60+52UI			ns
Detection time that the clock has stopped toggling	$T_{CLK-MISS}$			60	ns
Time to drive LP-00 to prepare for HS clock transmission	$T_{CLK-PREPARE}$	38		95	ns
Minimum lead HS-0 drive period before starting Clock	$T_{CLK-PREPARE} + T_{CLK-ZERO}$	300			ns
Time to enable Clock Lane receiver line termination measured from when Dn cross VIL,MAX	$T_{HS-TERM-EN}$			38	ns
Minimum time that the HS clock must be set prior to any associated date lane beginning the transmission from LP to HS mode	$T_{CLK-PRE}$	8			UI
Time to drive HS differential state after last payload clock bit of a HS transmission burst	$T_{CLK-TRAIL}$	60			ns

Bus Turnaround Procedure

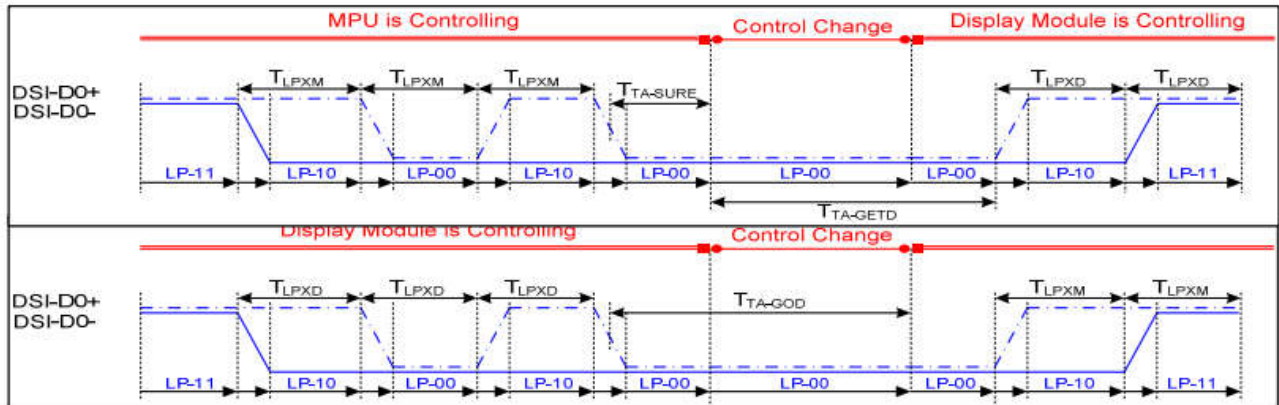

Parameter	Symbol	MIN	TYP	MAX	Unit
Length of any Low-Power state period : Master side	T_{LPX}	50		75	ns
Length of any Low-Power state period : Slave side	T_{LPX}	47.5	50	52.5	ns
Ratio of T_{LPX} (MASTER)/ T_{LPX} (SLAVE) between Master and Slave side	Ratio T_{LPX}	2/3		3/2	
Time-out before new TX side start driving	$T_{TA-SURE}$	T_{LPX}		$2 T_{LPX}$	ns
Time to drive LP-00 by new TX	T_{TA-GET}		$5 T_{LPX}$		ns
Time to drive LP-00 after Turnaround Request	T_{TA-GO}		$4 T_{LPX}$		ns

7. Optical Characteristics

Item	Symbol	Condition	Min.	Typ.	Max.	Unit	Note
Brightness	Bp	$\theta=0^\circ$	450	550	-	Cd/m ²	1
Uniformity	$\triangle Bp$	$\Phi=0^\circ$	70		-	%	1,2
Viewing Angle	3:00	Cr \geq 10	55	65	-	Deg	3
	6:00		45	55	-		
	9:00		55	65	-		
	12:00		55	65	-		
Contrast Ratio	Cr	$\theta=0^\circ$	600	800		-	4
Response Time	T _r	$\Phi=0^\circ$ 25 $^\circ$ C	-	20	30	ms	5
	T _f		-			ms	
Color of CIE Coordinate	W	x	0.235	0.285	0.335	-	1.6
		y	0.258	0.308	0.358	-	
	R	x	0.535	0.585	0.635	-	
		y	0.274	0.324	0.374	-	
	G	x	0.289	0.339	0.389	-	
		y	0.537	0.587	0.637	-	
	B	x	0.101	0.151	0.201	-	
		y	0.038	0.088	0.138	-	
NTSC Ratio	S		45	50	-	%	

Note: The parameter is slightly changed by temperature, driving voltage and materiel

Note 1: The data are measured after LEDs are turned on for 5 minutes. LCM displays full white. The brightness is the average value of 9 measured spots. Measurement equipment BM-7 (Φ 5mm)

Measuring condition:

- Measuring surroundings: Dark room.
- Measuring temperature: Ta=25 $^\circ$ C.
- Adjust operating voltage to get optimum contrast at the center of the display.

Measured value at the center point of LCD panel after more than 5 minutes while backlight turning on.

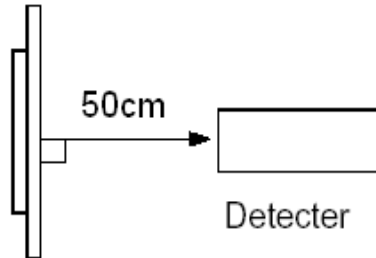

Note 2: The luminance uniformity is calculated by using following formula.

$$\Delta Bp = Bp (\text{Min.}) / Bp (\text{Max.}) \times 100 (\%)$$

$Bp (\text{Max.})$ = Maximum brightness in 9 measured spots

$Bp (\text{Min.})$ = Minimum brightness in 9 measured spots.

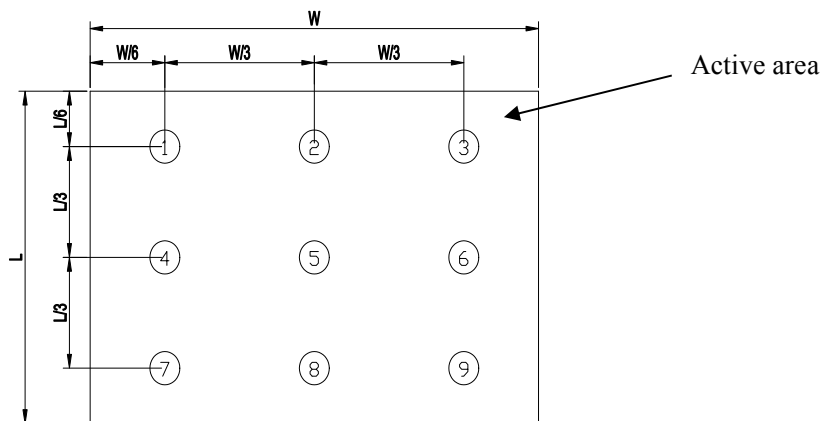

Note 3: The definition of viewing angle:

Refer to the graph below marked by ϑ and ϕ

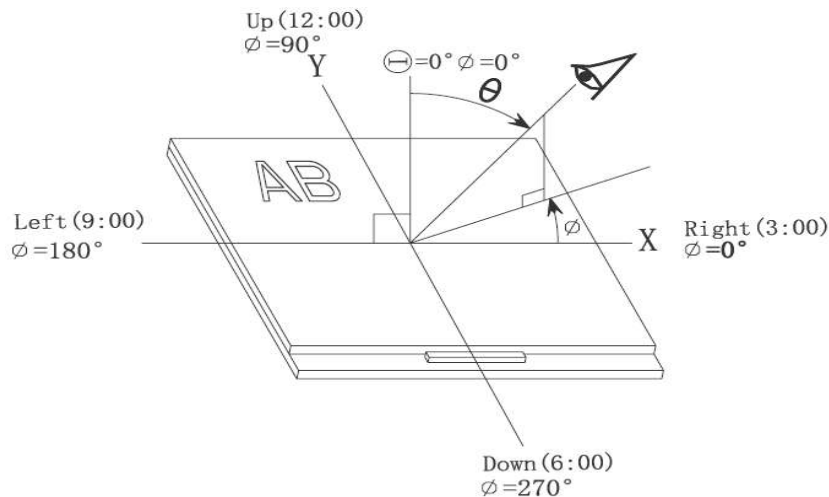

Note 4: Definition of contrast ratio.(Test LCD using DMS501)

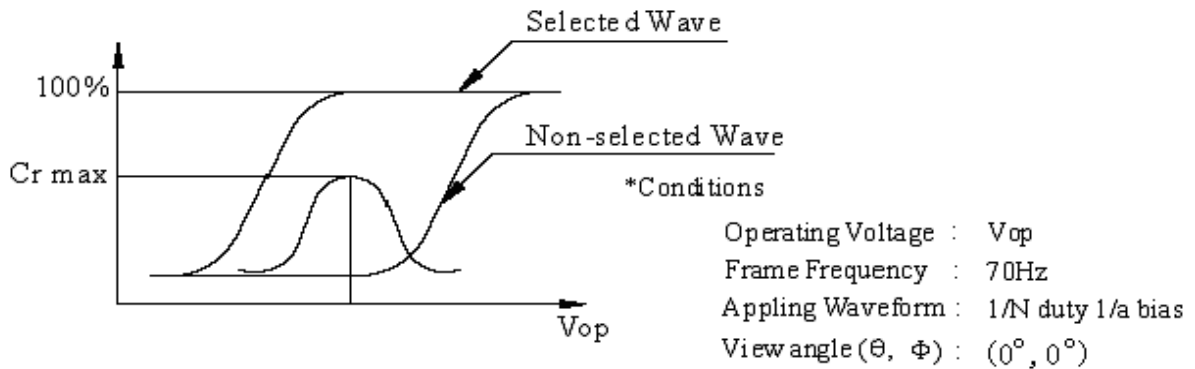

$$\text{Contrast ratio}(Cr) = \frac{\text{Brightness of selected dots}}{\text{Brightness of non-selected dots}}$$

Note 5: Definition of Response time. (Test LCD using DMS501):

The output signals of photo detector are measured when the input signals are changed from “black” to “white”(falling time) and from “white” to “black”(rising time), respectively. The response time is defined as the time interval between the 10% and 90% of amplitudes.Refer to figure as below.

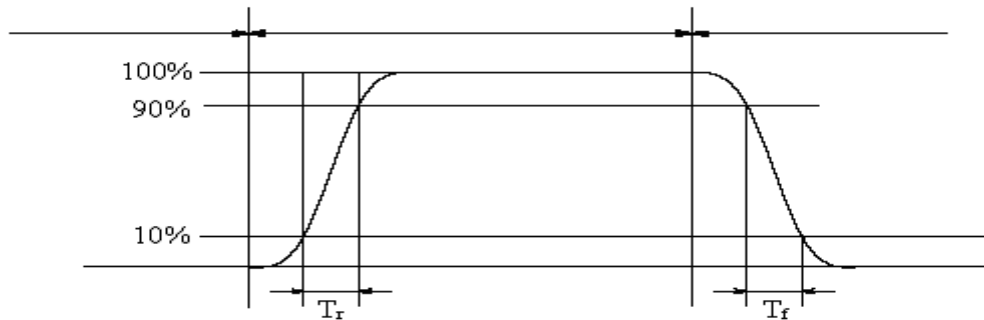

The definition of response time

Note 6: Definition of Color of CIE Coordinate and NTSC Ratio.

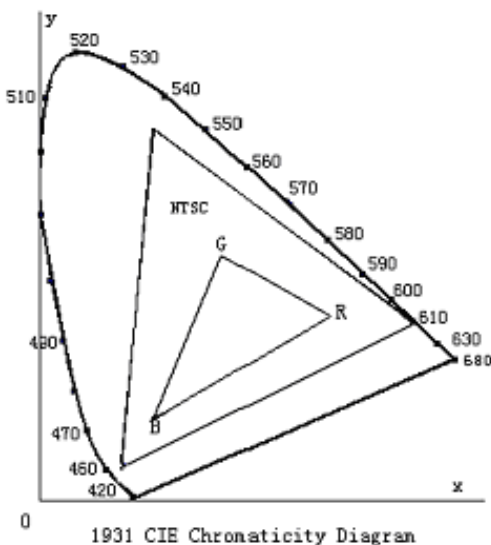

Color gamut:

$$S = \frac{\text{area of RGB triangle}}{\text{area of NTSC triangle}} \times 100\%$$

Note 7: Definition of cross talk.

Cross talk ratio(%)=|pattern A Brightness-pattern B Brightness|/pattern A Brightness*100

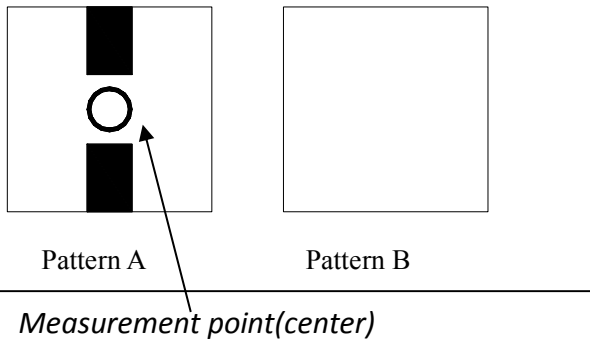

Electric volume value=3F+/-3Hex

8. CTP Specification

8.1 GENERAL SPECIFICATIONS

Item	Specification	Unit
Type	Project capacitive type touch panel	-
Structure	Cover glass+Film sensor +FPCA	-
Input mode	Humans finger	-
Finger	Up to 5	-
Resolution	320x320	dots
Cover V.A	61.0x61.0	mm
Sensor A.A	62.5x62.5	mm
Hardness	>=6H	Pressure 750g force, 45°
Driver IC	FT5216	-

8.2 ABSOLUTE MAXIMUM RATINGS

Symbol	Description	Min	Typ	Max	Unit	Notes
VCC	Supply voltage	2.8	3.3	3.6	V	
ICC	Supply current	-	TBD	-	mA	
VIH	Input high-level voltage	0.7Vcc	-	Vcc	V	
VIL	Input low-level voltage	-0.3	-	0.3Vcc	V	
VOH	Output high -level voltage	0.7Vcc	-	-	V	
VOL	Output low-level voltage	-	-	0.3Vcc	V	

8.3 CTP PIN ASSIGNMENT

Pin No.	Symbol	I/O	Function
1	GND	P	Ground.
2	RST	I	Reset.
3	VDD	P	Power supply.
4	INT	I	Interrupt signal to host from CTP.
5	SCL	I	I ² C clock signal.
6	SDA	I	I ² C data signal.

8.4 BLOCK DIAGRAM

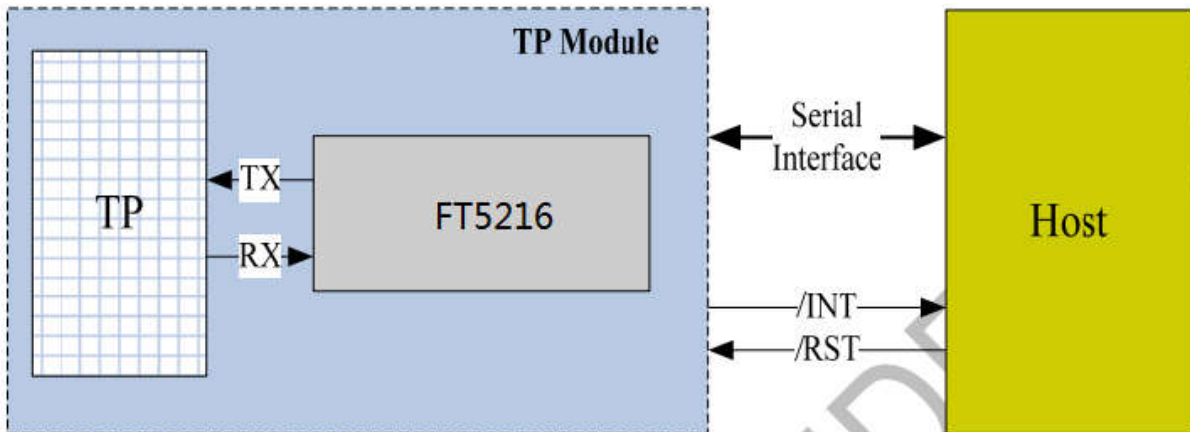

Figure 2-3 HostInterface Diagram

8.5 CTP timing

The I2C is always configured in the Slave mode. The data transfer format is shown in Figure 1-1.

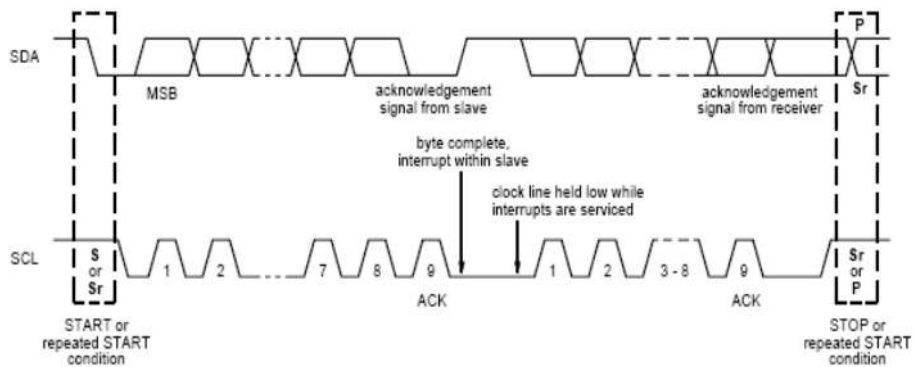

Figure 1-1 I2C Serial Data Transfer Format

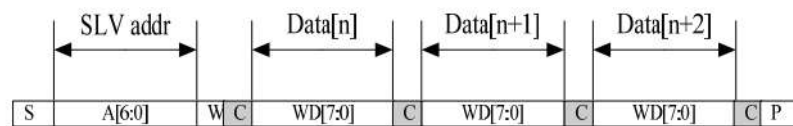

Figure 1-2 I2C master write, slave read

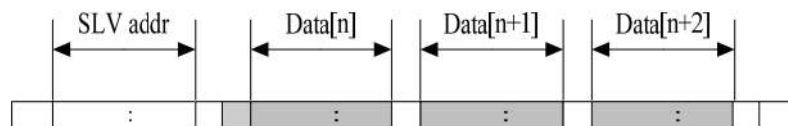

Figure 1-3 I2C master read, slave write

Table 1-1 lists the meanings of the mnemonics used in the above figures.

Table 1-1 Mnemonics Description

Mnemonics	Description
S	I2C Start or I2C Restart
A[6:0]	Slave address A[6:4]: 3'b011 A[3:0]: data bits are identical to those of I2CCON[7:4] register.
W	1'b0: Write
R	1'b1: Read
C	ACK
P	STOP: the indication of the end of a packet (if this bit is missing, S will indicate the end of the current packet and the beginning of the next packet)

I2C Interface Timing Characteristics is shown in Table 1-2.

Table 1-2 I2C Timing Characteristics

Parameter	Unit	Min	Max
SCL frequency	KHz	0	400
Bus free time between a STOP and START condition	us	4.7	\
Hold time (repeated) START condition	us	4.0	\
Data setup time	ns	250	\
Setup time for a repeated START condition	us	4.7	\
Setup Time for STOP condition	us	4.0	\

Note: More information pls refer to IC spec.

9. Reliability Test Items and Criteria

No	Test Item	Test condition	Criterion
1	High Temperature Storage	80°C±2°C 96H Restore 2H at 25°C Power off	1. After testing, cosmetic and electrical defects should not happen. 2. Total current consumption should not be more than twice of initial value.
2	Low Temperature Storage	-30°C±2°C 96H Restore 2H at 25°C Power off	
3	High Temperature Operation	70°C±2°C 96H Restore 2H at 25°C Power on	
4	Low Temperature Operation	-20°C±2°C 96H Restore 4H at 25°C Power on	
5	High Temperature/Humidity Operation	60°C±2°C 90%RH 96H Power on	
6	Temperature Cycle	$-30^{\circ}\text{C} \xrightarrow{\hspace{2cm}} 80^{\circ}\text{C}$ 30min 5min 30min after 5 cycle, Restore 2H at 25°C Power off	

Note: Operation: Supply 3.3V for logic system.

The inspection terms after reliability test, as below

ITEM	Inspection
Contrast	CR>50%
IDD	IDD<200%
Brightness	Brightness>60%
Color Tone	Color Tone+/-0,05

10. Precautions for Use of LCD Modules

10.1 Handling Precautions

10.1.1 *The display panel is made of glass. Do not subject it to a mechanical shock by dropping it from a high place, etc.*

10.1.2 *If the display panel is damaged and the liquid crystal substance inside it leaks out, be sure not to get any in your mouth, if the substance comes into contact with your skin or clothes, promptly wash it off using soap and water.*

10.1.3 *Do not apply excessive force to the display surface or the adjoining areas since this may cause the color tone to vary.*

10.1.4 *The polarizer covering the display surface of the LCD module is soft and easily scratched. Handle this polarizer carefully.*

10.1.5 *If the display surface is contaminated, breathe on the surface and gently wipe it with a soft dry cloth. If still not completely clear, moisten cloth with one of the following solvents:*

— Isopropyl alcohol — Ethyl alcohol

Solvents other than those mentioned above may damage the polarizer. Especially, do not use the following:

— Water — Ketone — Aromatic solvents

10.1.6 *Do not attempt to disassemble the LCD Module.*

10.1.7 *If the logic circuit power is off, do not apply the input signals.*

10.1.8 *To prevent destruction of the elements by static electricity, be careful to maintain an optimum work environment.*

a. Be sure to ground the body when handling the LCD Modules.

b. Tools required for assembly, such as soldering irons, must be properly ground.

c. To reduce the amount of static electricity generated, do not conduct assembly and other work under dry conditions.

d. The LCD Module is coated with a film to protect the display surface. Be care when peeling off this protective film since static electricity may be generated.

10.2 Storage precautions

10.2.1 *When storing the LCD modules, avoid exposure to direct sunlight or to the light of fluorescent lamps.*

10.2.2 *The LCD modules should be stored under the storage temperature range. If the LCD modules will be stored for a long time, the recommend condition is:*

Temperature : 0 °C ~ 40 °C

Relatively humidity: ≤80%

10.2.3 *The LCD modules should be stored in the room without acid, alkali and harmful gas.*

10.3 *The LCD modules should be no falling and violent shocking during transportation, and also should avoid excessive press, water, damp and sunshine.*

END

Our company network supports you worldwide with offices in Germany, Austria, Switzerland, the UK and the USA. For more information please contact:

Headquarters

Germany



FORTEC Elektronik AG

Lechwiesenstr. 9
86899 Landsberg am Lech

Phone: +49 8191 91172-0
E-Mail: sales@forteca.de
Internet: www.forteca.de

Fortec Group Members

Austria



FORTEC Elektronik AG

Office Vienna

Nuschinggasse 12
1230 Wien

Phone: +43 1 8673492-0
E-Mail: office@fortec.at
Internet: www.fortec.at

Germany



Distec GmbH

Augsburger Str. 2b
82110 Germering

Phone: +49 89 894363-0
E-Mail: info@distec.de
Internet: www.distec.de

Switzerland



ALTRAC AG

Bahnhofstraße 3
5436 Würenlos

Phone: +41 44 7446111
E-Mail: info@altrac.ch
Internet: www.altrac.ch

United Kingdom



Display Technology Ltd.

Osprey House, 1 Osprey Court
Hichingbrooke Business Park
Huntingdon, Cambridgeshire, PE29 6FN

Phone: +44 1480 411600
E-Mail: info@displaytechnology.co.uk
Internet: www.displaytechnology.co.uk

USA



Apollo Display Technologies, Corp.

87 Raynor Avenue,
Unit 1 Ronkonkoma,
NY 11779

Phone: +1 631 5804360
E-Mail: info@apolloDisplays.com
Internet: www.apolloDisplays.com