



Disea Electronics Co., LTD

Tel:+86-0755-2373-1499 Fax:+86-0755-2373-1466

E-mail:sales@diseelec.com URL:www.diseelec.com

ADD: 4F,#3 Building, TianFuAn Industrial park,
LeZhuJiao, ZhouShi Road,XiXiang Town, BaoAn
District, ShenZhen City, GuangDong Province , China

PRODUCT SPECIFICATIONS

For Customer: _____

: APPROVAL FOR SPECIFICATION

Customer Model No. _____

: APPROVAL FOR SAMPLE

Module No.: ZW-T050HWSA-37CP

Date : 2023-01-11

Table of Contents

No.	Item	Page
1	Cover Sheet(Table of Contents)	P1
2	Revision Record	P2
3	General Specifications	P3
4	Outline Drawing	P4
5	Absolute Maximum Ratings	P5
6	Electrical Specifications and Instruction Code	P6-P11
7	Optical Characteristics	P12-P15
8	Reliability Test Items and Criteria	P16
9	Precautions for Use of LCD Modules	P17-P18

For Customer's Acceptance:

Approved By	Comment

PREPARED	CHECKED	VERIFIED BY QA DEPT	VERIFIED BY R&D DEPT
ZKJ			

3. General Specifications

ZW-T050HWSA-37CP is a TFT-LCD module. It is composed of a TFT-LCD panel, driver IC, FPC, a back light unit and CTP. The 5.0'' display area contains 800 x (RGB) x 480 pixels and can display up to 16.7M colors. This product accords with RoHS environmental criterion.

Item	Contents	Unit	Note
LCD Type	TFT	-	
Display color	16.7M		
Viewing Direction	ALL	O'Clock	
Operating temperature	-20~+70	°C	
Storage temperature	-30~+80	°C	
Module size	Refer to outline drawing	mm	
Active Area(W×H)	108.00X 64.80	mm	
Number of Dots	800×480	dots	
Controller	ST7262	-	
CTP Controller	FT5426	-	
Power Supply Voltage	3.3	V	
Outline Dimensions	Refer to outline drawing	-	
Backlight	6X3-LEDs	pcs	
Weight	---	g	
Interface	RGB Interface	-	

Note 1: Color tune is slightly changed by temperature and driving voltage.

Note 2: Without FPC and Solder.

4.Outline.Drawing

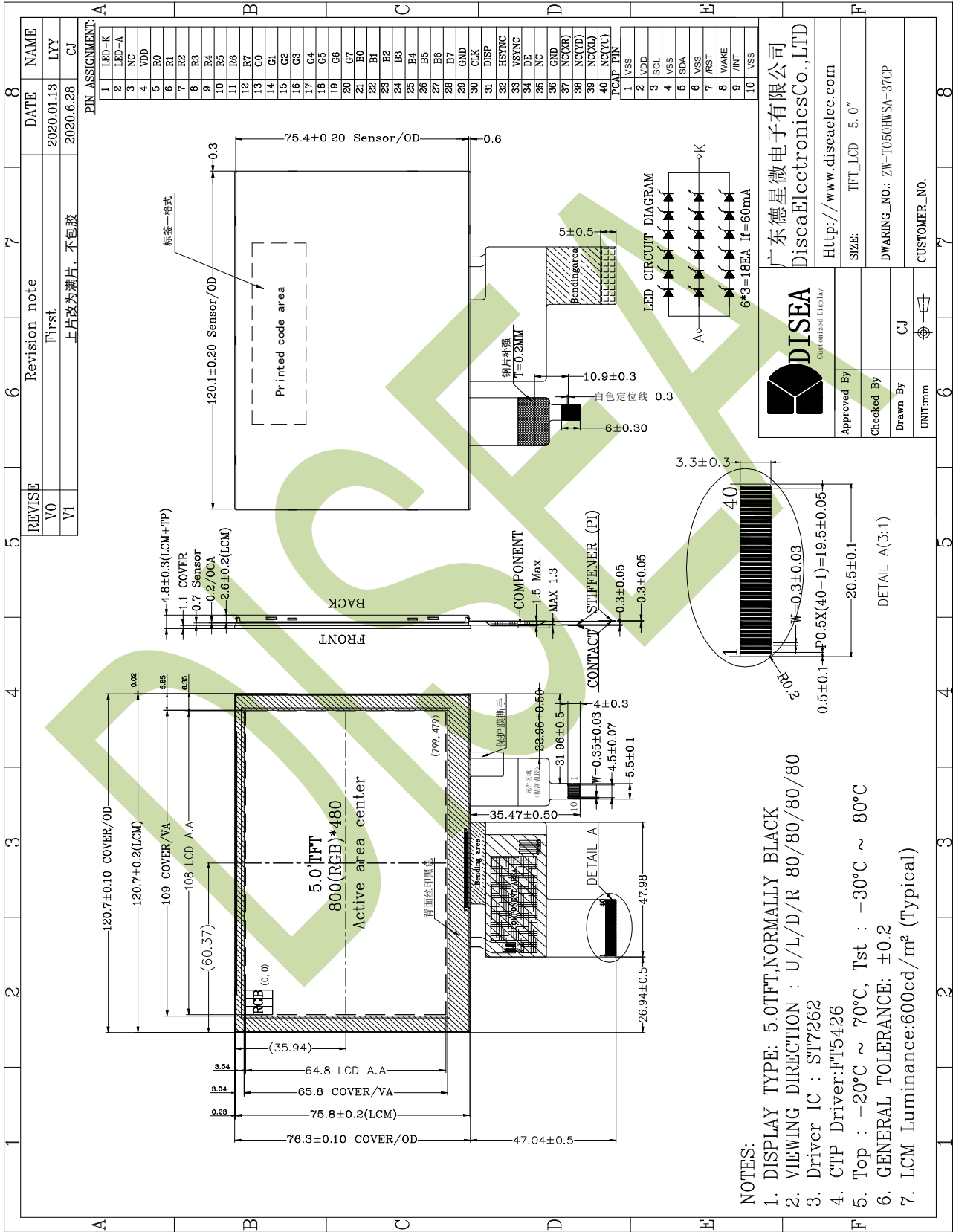

DISEA
Customized Display

广东德星微电子有限公司
DiseaElectronicsCo.,LTD

Http://www.diseaelec.com

Approved By: [Signature]

Checked By: [Signature]

Drawn By: CJ

UNIT:mm

SIZE: TFT_LCD 5.0"

DWARING_NO.: ZW-T050HWSA-37CP

CUSTOMER_NO.

5. Absolute Maximum Ratings(Ta=25°C)

5.1 Electrical Absolute Maximum Ratings.(Vss=0V ,Ta=25°C)

Item	Symbol	Min.	Max.	Unit	Note
Power Supply Voltage	V _{DD}	-0.3	4.0	V	1, 2

Notes:

- If the module is above these absolute maximum ratings. It may become permanently damaged. Using the module within the following electrical characteristic conditions are also exceeded, the module will malfunction and cause poor reliability.
- V_{CC} > V_{SS} must be maintained.

5.2 Environmental Absolute Maximum Ratings.

Item	Storage		Operating		Note
	MIN.	MAX.	MIN.	MAX.	
Ambient Temperature	-30°C	80°C	-20°C	70°C	1,2
Humidity	-	-	-	-	3

- The response time will become lower when operated at low temperature.
- Background color changes slightly depending on ambient temperature.
The phenomenon is reversible.
- Ta <= 40 °C: 85%RH MAX.
Ta >= 40 °C: Absolute humidity must be lower than the humidity of 85%RH at 40 °C.

6. Electrical Specifications and Instruction Code

6.1 Electrical characteristics ($V_{SS}=0V, T_a=25^\circ C$)

Parameter	Symbol	Condition	Min	Typ	Max	Unit	Note
Power supply	VDD	$T_a=25^\circ C$	3.0	3.3	3.6	V	
Input voltage	'H'	V_{IH}	VDD=3.3V	0.7VDD	-	VDD	V
	'L'	V_{IL}	VDD=3.3V	0	-	0.3VDD	V

6.2 LED backlight specification ($V_{SS}=0V, T_a=25^\circ C$)

Item	Symbol	Condition	Min	Typ	Max	Unit	Note
Supply voltage	V_f	$I_f=40mA$	-	18	-	V	
Uniformity	ΔB_p	$I_f=40mA$	80	-	-	%	
Life Time	time	$I_f=40mA$	20K	-	-	hours	1

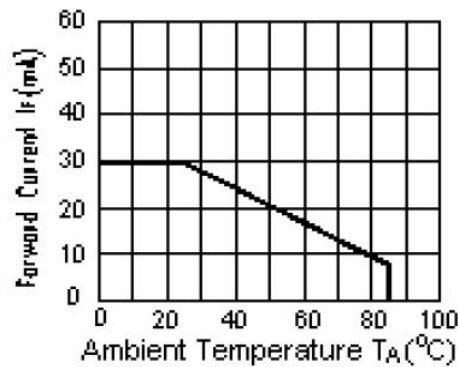

Note 1: Brightness to be decreased to 50% of the initial value at ambient temperature $T_A=25^\circ C$

6.3 Interface signals

Pin No.	Symbol	I/O	Function
1	LEDK	P	LED back light (Cathode).
2	LEDA	P	LED back light (Anode).
3	NC	-	No connection.
4	VDD	P	Power supply.
5-12	R0-R7	I	Red data bus.
13-20	G0-G7	I	Green data bus.
21-28	B0-B7	I	Blue data bus.
29	GND	P	Ground.
30	CLK	I	pixel clock input pin.
31	DISP	I	DISP sets the display mode.
32	HSYNC	I	Line sync input.
33	VSYNC	I	Frame sync input.
34	DE	I	Data input enable applied to the RGB interface.
35	NC	-	No connection.
36	GND	P	Ground.
37	NC(XR)	O	Touch Panel Control pin.
38	NC(YD)	O	
39	NC(XL)	O	
40	NC(YU)	O	

CTP Interface

Pin No.	Symbol	I/O	Function
1	VSS	P	CTP Ground.
2	VDD	p	CTP Power supply.
3	SCL	I	CTP serial clock signal.
4	VSS	P	CTP Ground.
5	SDA	I	CTP serial Input/output data bus.
6	VSS	P	CTP Ground.
7	/RST	I	CTP Global reset signal input pin.
8	WAKE	I	CTP reset the display.
9	/INT	I	external Interrupt to the IC of CTP.
10	VSS	P	CTP Ground.

6.4 AC Characteristics

SYNC Mode

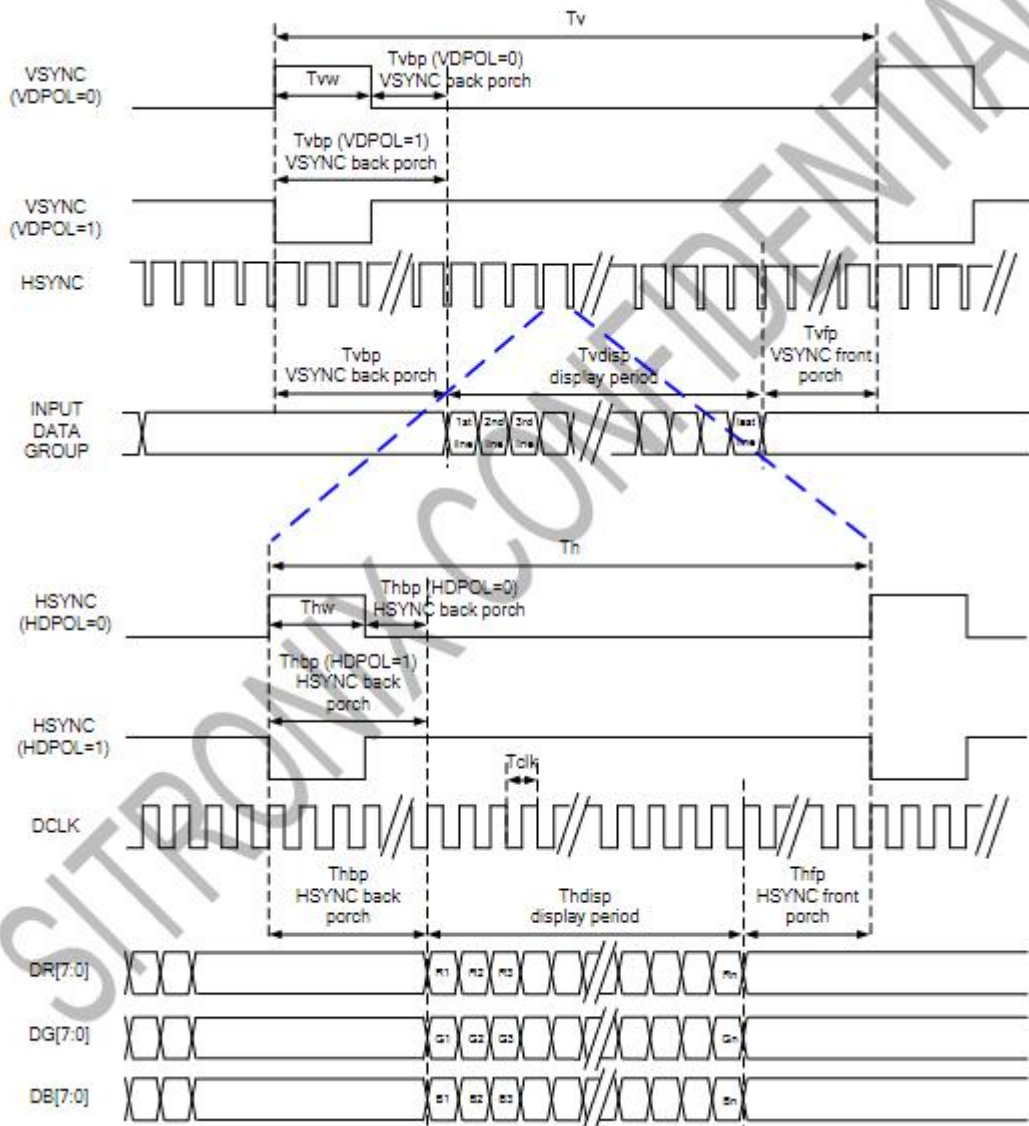

SYNC-DE Mode

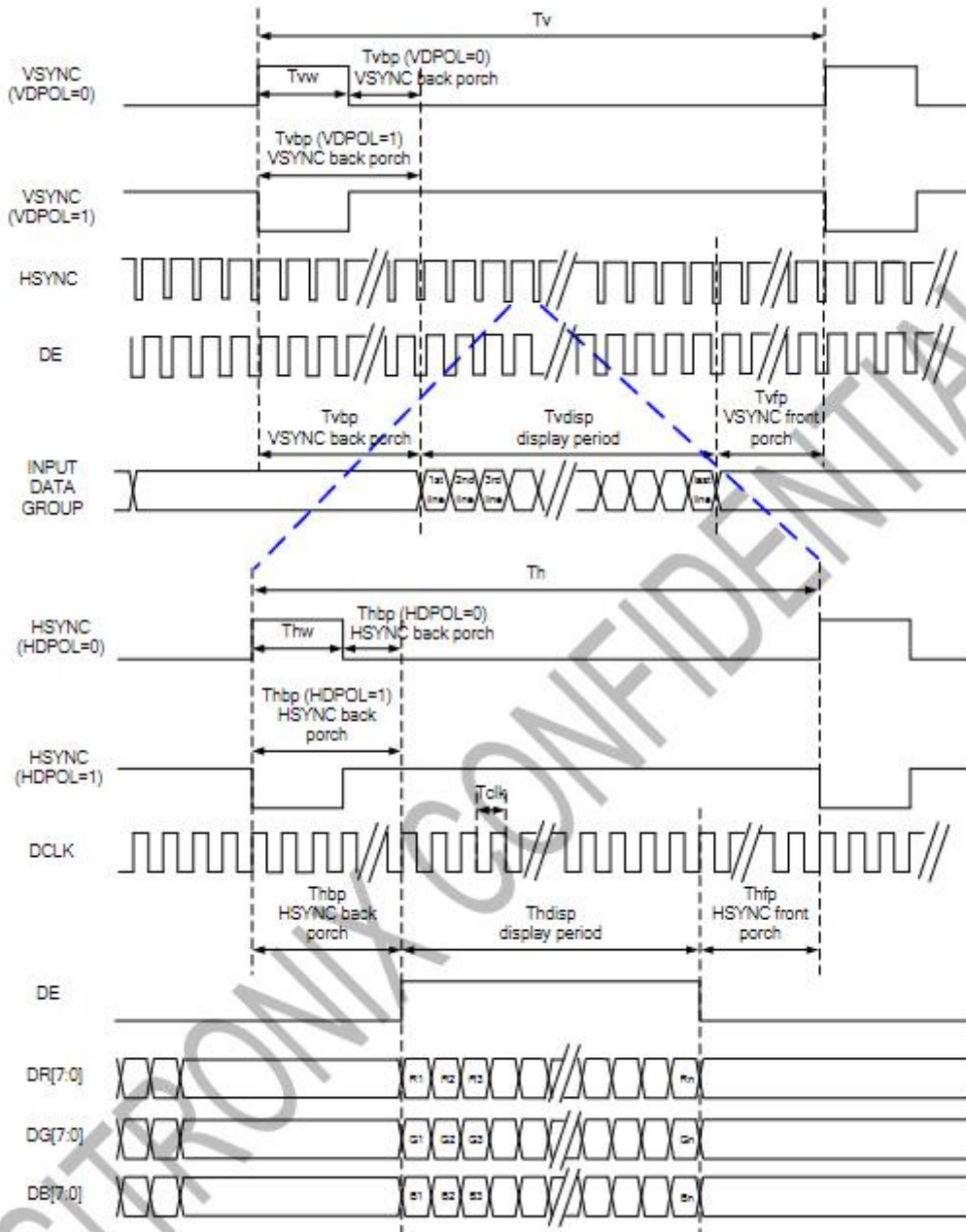

DE Mode

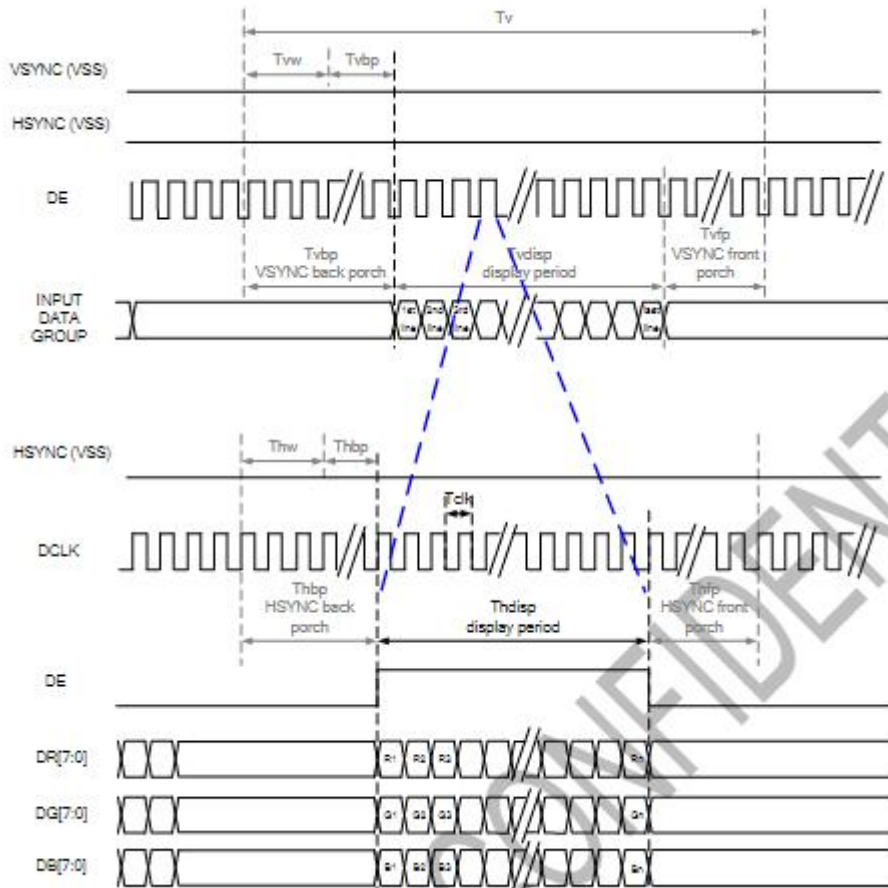

Parallel 24-bit RGB Input Timing Table

Parallel 24-bit RGB Interface Timing Table							
Item	Symbol	Min.	Typ.	Max.	Unit	Remark	
DCLK Frequency		Fclk	23	25	27	MHz	
HSYNC	Period Time	T_h	808	816	896	DCLK	
	Display Period	T_{hdisp}	800			DCLK	
	Back Porch	T_{hbp}	4	8	48	DCLK	
	Front Porch	T_{hfp}	4	8	48	DCLK	
	Pulse Width	T_{hw}	2	4	8	DCLK	
VSYNC	Period Time	T_v	492	496	504	HSYNC	
	Display Period	T_{vdisp}	480			HSYNC	
	Back Porch	T_{vbp}	6	8	12	HSYNC	
	Front Porch	T_{vfp}	6	8	12	HSYNC	
	Pulse Width	T_{vw}	2	4	8	HSYNC	

7. Optical Characteristics

Item	Symbol	Condition	Min.	Typ.	Max.	Unit	Note
Brightness	Bp	$\theta=0^\circ$ $\Phi=0^\circ$	-	600	-	Cd/m ²	1
Uniformity	ΔBp		80	-	-	%	1,2
Viewing Angle	3:00	Cr \geq 10	-	80	-	Deg	1
	6:00		-	80	-		
	9:00		-	80	-		
	12:00		-	80	-		
Contrast Ratio	Cr	$\theta=0^\circ$ $\Phi=0^\circ$	800	1000	-	-	4
Response Time	T _r + T _f		-	30	40	ms	5
Color of CIE Coordinate	W	x	$\theta=0^\circ$ $\Phi=0^\circ$	0.320	Typ -0.05	-	1,6
		y		0.345		-	
	R	x		0.629		-	
		y		0.326		Typ +0.05	
	G	x		0.337		-	
		y		0.546		-	
	B	x		0.136		-	
		y		0.143		-	
NTSC Ratio	S	45	50	-	%		

Note: The parameter is slightly changed by temperature, driving voltage and materiel

Note 1: The data are measured after LEDs are turned on for 5 minutes. LCM displays full white. The brightness is the average value of 9 measured spots. Measurement equipment PR-705 (Φ8mm)

Measuring condition:

- *Measuring surroundings: Dark room.*
- *Measuring temperature: Ta=25 °C.*
- *Adjust operating voltage to get optimum contrast at the center of the display.*

Measured value at the center point of LCD panel after more than 5 minutes while backlight

turning on.

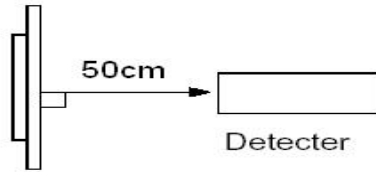

Note 2: The luminance uniformity is calculated by using following formula.

$$\Delta Bp = Bp (\text{Min.}) / Bp (\text{Max.}) \times 100 (\%)$$

$Bp (\text{Max.})$ = Maximum brightness in 9 measured spots

$Bp (\text{Min.})$ = Minimum brightness in 9 measured spots.

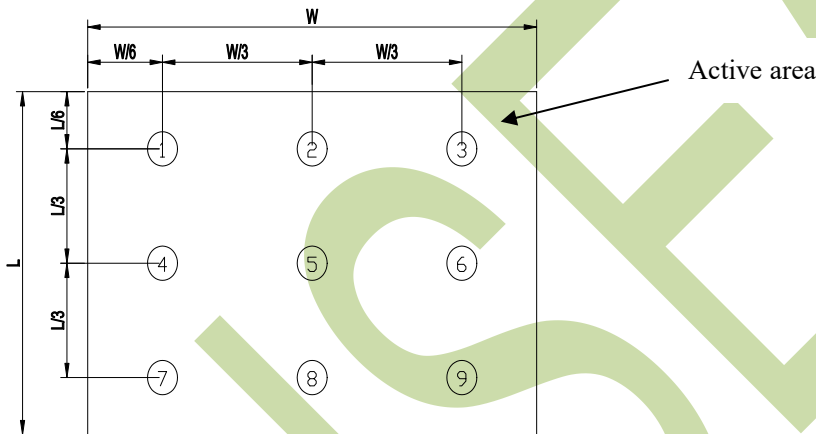

Note 3: The definition of viewing angle:

Refer to the graph below marked by ϑ and ϕ

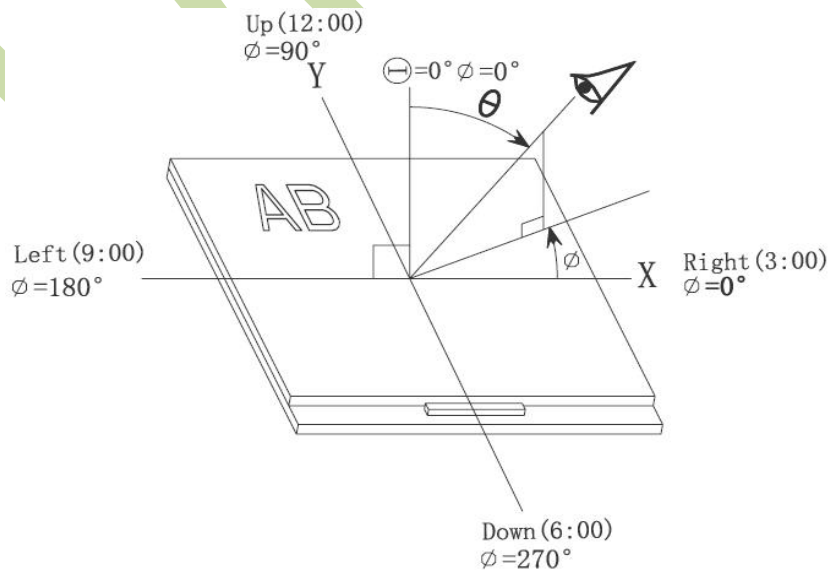

Note 4: Definition of contrast ratio.(Test LCD using DMS501)

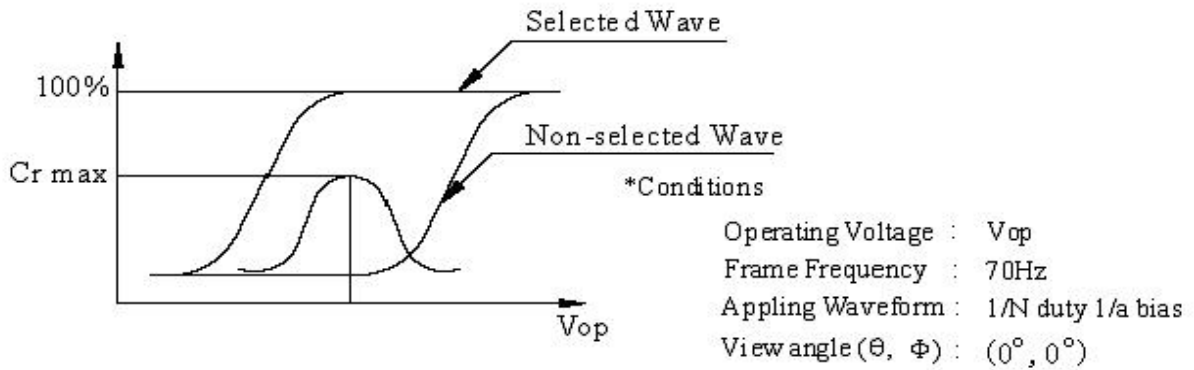

$$\text{Contrast ratio}(Cr) = \frac{\text{Brightness of selected dots}}{\text{Brightness of non-selected dots}}$$

Note 5: Definition of Response time. (Test LCD using DMS501):

The output signals of photo detector are measured when the input signals are changed from "black" to "white"(falling time) and from "white" to "black"(rising time), respectively. The response time is defined as the time interval between the 10% and 90% of amplitudes. Refer to figure as below.

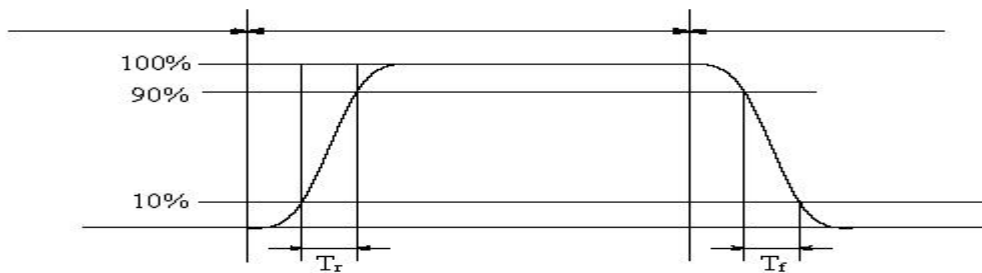

The definition of response time

Note 6: Definition of Color of CIE Coordinate and NTSC Ratio.

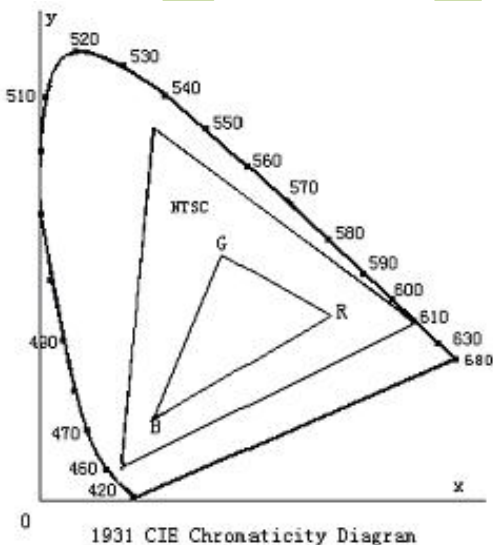

Color gamut:

$$S = \frac{\text{area of RGB triangle}}{\text{area of NTSC triangle}} \times 100\%$$

Note 7: Definition of cross talk.

$$\text{Cross talk ratio(\%)} = \frac{|\text{pattern A Brightness} - \text{pattern B Brightness}|}{\text{pattern A Brightness}} * 100$$

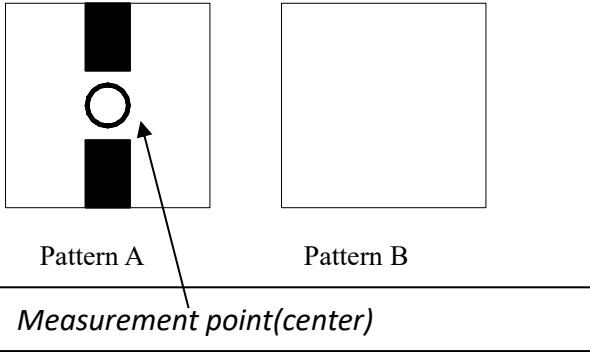

Electric volume value=3F+/-3Hex

DISEA

8. Reliability Test Items and Criteria

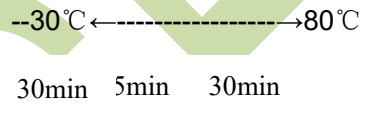
No	Test Item	Test condition	Criterion
1	High Temperature Storage	80°C±2°C 96H Restore 2H at 25°C Power off`	1. After testing, cosmetic and electrical defects should not happen. 2. Total current consumption should not be more than twice of initial value.
2	Low Temperature Storage	-30°C±2°C 96H Restore 2H at 25°C Power off	
3	High Temperature Operation	70°C±2°C 96H Restore 2H at 25°C Power on	
4	Low Temperature Operation	-20°C±2°C 96H Restore 4H at 25°C Power on	
5	High Temperature/Humidity Operation	60°C±2°C 90%RH 96H Power on	
6	Temperature Cycle	 30min 5min 30min after 5 cycle, Restore 2H at 25°C Power off	

Note: Operation: Supply 2.8V for logic system.

The inspection terms after reliability test, as below

ITEM	Inspection
Contrast	CR>50%
IDD	IDD<200%
Brightness	Brightness>60%
Color Tone	Color Tone+/-0,05

9. Precautions for Use of LCD Modules

9.1 Handling Precautions

9.1.1 *The display panel is made of glass. Do not subject it to a mechanical shock by dropping it from a high place, etc.*

9.1.2 *If the display panel is damaged and the liquid crystal substance inside it leaks out, be sure not to get any in your mouth, if the substance comes into contact with your skin or clothes, promptly wash it off using soap and water.*

9.1.3 *Do not apply excessive force to the display surface or the adjoining areas since this may cause the color tone to vary.*

9.1.4 *The polarizer covering the display surface of the LCD module is soft and easily scratched. Handle this polarizer carefully.*

9.1.5 *If the display surface is contaminated, breathe on the surface and gently wipe it with a soft dry cloth. If still not completely clear, moisten cloth with one of the following solvents:*

- Isopropyl alcohol*
- Ethyl alcohol*

Solvents other than those mentioned above may damage the polarizer. Especially, do not use the following:

- Water*
- Ketone*
- Aromatic solvents*

9.1.6 *Do not attempt to disassemble the LCD Module.*

9.1.7 *If the logic circuit power is off, do not apply the input signals.*

9.1.8 *To prevent destruction of the elements by static electricity, be careful to maintain an optimum work environment.*

- a. Be sure to ground the body when handling the LCD Modules.*
- b. Tools required for assembly, such as soldering irons, must be properly ground.*
- c. To reduce the amount of static electricity generated, do not conduct assembly and other work under dry conditions.*
- d. The LCD Module is coated with a film to protect the display surface. Be care when peeling off this protective film since static electricity may be generated.*

9.2 Storage precautions

9.2.1 *When storing the LCD modules, avoid exposure to direct sunlight or to the light of fluorescent*

lamps.

9.2.2 The LCD modules should be stored under the storage temperature range. If the LCD modules will be stored for a long time, the recommend condition is:

Temperature : 0 °C ~ 40 °C

Relatively humidity: ≤80%

9.2.3 The LCD modules should be stored in the room without acid, alkali and harmful gas.

9.3 The LCD modules should be no falling and violent shocking during transportation, and also should avoid excessive press, water, damp and sunshine.

END

DISEA